

# LINEA BELLA



customcrafters

# MEET THE COLLECTION

Though Custom Crafters is known for custom pieces, we saw an opportunity to tighten lead times and keep sustainable practices top of mind by designing our own line of “made to measure” office furniture, with standard options available in select sizes. Thus, Linea Bella was conceptualized.

Completely designed and produced by Custom Crafters, Linea Bella is a truly inspirational line of American-made furniture that’s beautiful, artfully-crafted yet priced competitively. Drawing inspiration from Italian design and craftsmanship, the furniture has simple and elegant lines which bring a classic, sophisticated look to any space.

With Linea Bella, each piece is approached with the same attention to detail you’ve come to expect from Custom Crafters’ artisans. **Meet Linea Bella.**

## CONTENTS

MILANO RECEPTION DESK	4
SALERNO COLLABORATIVE TABLE	10
TORINO CONFERENCE TABLE	16
TORINO CREDENZA	22
VENICE CONFERENCE TABLE	28
VENICE CREDENZA	34

# MILANO RECEPTION DESK

A nod to fashion, the Milano Reception Desk situates perfectly within the whole Linea Bella collection or as a standalone piece, striking and commanding attention without being ornate.

# MILANO RECEPTION DESK



MILANO RECEPTION DESK  
IN WALNUT VENEER



MILANO RECEPTION  
DESK IN PEWTER PINE



MILANO RECEPTION  
DESK IN BLACK

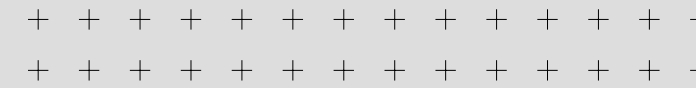

## + SPECIFICATION NOTES

✓ Solid surface (SS) finishes can be specified on any surface tops. Plastic laminate (PL) can be specified on any surface tops or bases.

Wood finish (WD) can only be specified for the bases.

● The transaction top can be specified in the center, to the left or right -- as viewed from the front. It is not adjustable in the field, so it must be specified upon order so the drill holes align.

Transaction counter is a preassembled unit with predetermined mounting location.

Reception desk comes standard without storage. Can be specified with optional matching box/box/file, file/file and/or lateral file cabinets.

See Pricing on Page 41

## + MATERIAL SPECIFICATIONS

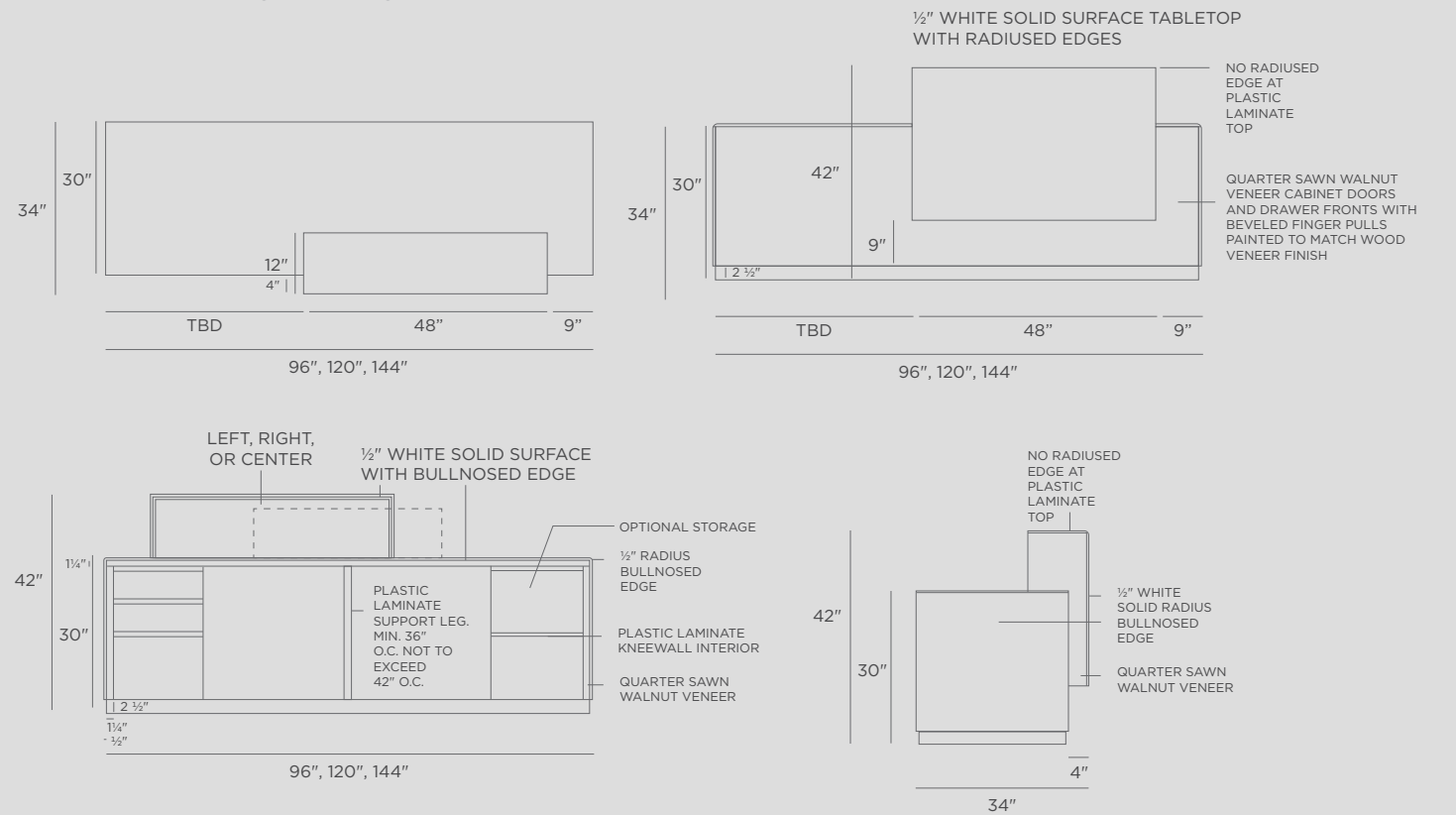
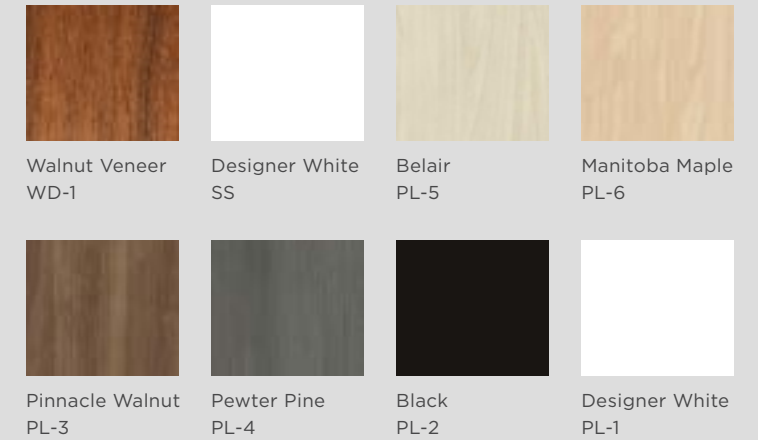



++++++  
++++++  
++++++  
++++++



++++++  
++++++

# SALERNO COLLABORATIVE TABLE

The Salerno Collaborative Table, named after the lively port town, features sleek, uncomplicated lines for a contemporary look. Its bullnose edge and subtle quirk give it a look that is both timeless and sophisticated. Its clean lines and simple design make it a versatile piece of furniture that can be used in a variety of settings.

# SALERNO COLLABORATIVE TABLE



SALERNO COLLABORATIVE TABLE  
IN WALNUT VENEER



SALERNO COLLABORATIVE  
TABLE IN PEWTER PINE



SALERNO COLLABORATIVE  
TABLE IN BLACK

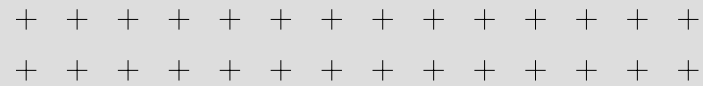

## + SPECIFICATION NOTES







✓ Solid surface (SS) finishes can be specified on any surface tops. Plastic laminate (PL) can be specified on any surface tops or bases.

Wood finish (WD) can only be specified for the bases.

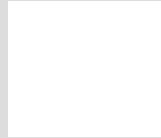
● Tables ship knock-down. Assembly required.

**See Pricing on Page 43**

## + MATERIAL SPECIFICATIONS

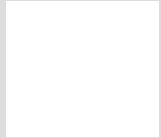
			
Walnut Veneer WD-1	Designer White SS	Belair PL-5	Manitoba Maple PL-6
			
Pinnacle Walnut PL-3	Pewter Pine PL-4	Black PL-2	Designer White PL-1

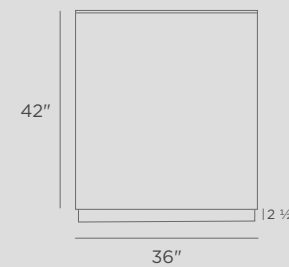
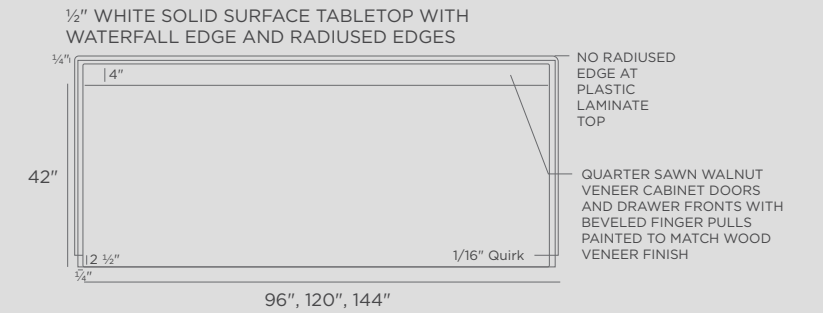
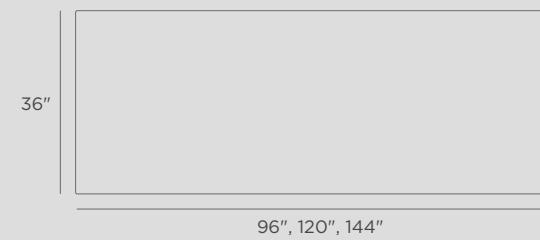

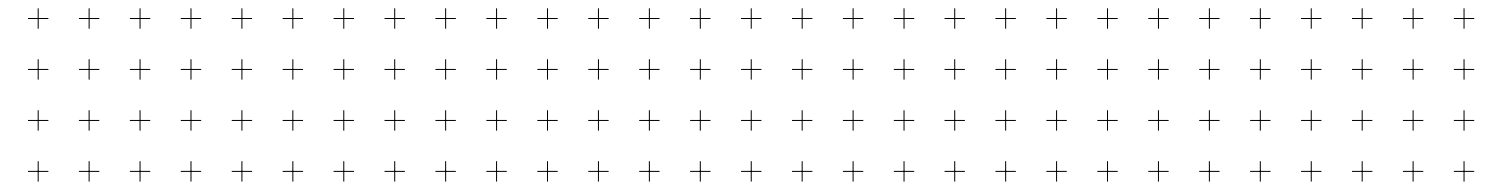



# TORINO CONFERENCE TABLE

Drawing inspiration from the lively and elegant city at the foot of the Alps, the Torino Conference Table brings a feeling of strength, style and excellent performance to meeting rooms. The combination of materials procured, excellent craftsmanship and state of the art technology create a table that is both beautiful and powerful. The legs are true 4x4s with a solid surface top that is 0.5" thick. The four legs appear to punch through the countertop and celebrate the structure and fabrication of the piece itself.

# TORINO CONFERENCE TABLE



TORINO CONFERENCE TABLE  
IN WALNUT VENEER



TORINO CONFERENCE TABLE IN  
BLACK



TORINO CONFERENCE TABLE IN  
PEWTER PINE

## LINEA BELLA



### + SPECIFICATION NOTES

✓ Solid surface (SS) finishes can be specified on any surface tops. Plastic laminate (PL) can be specified on any surface tops or bases.

Wood finish (WD) can only be specified for the bases.

● Tables ship knock-down. Assembly required.

**SEE PRICING ON PAGE 44**

### + MATERIAL SPECIFICATIONS

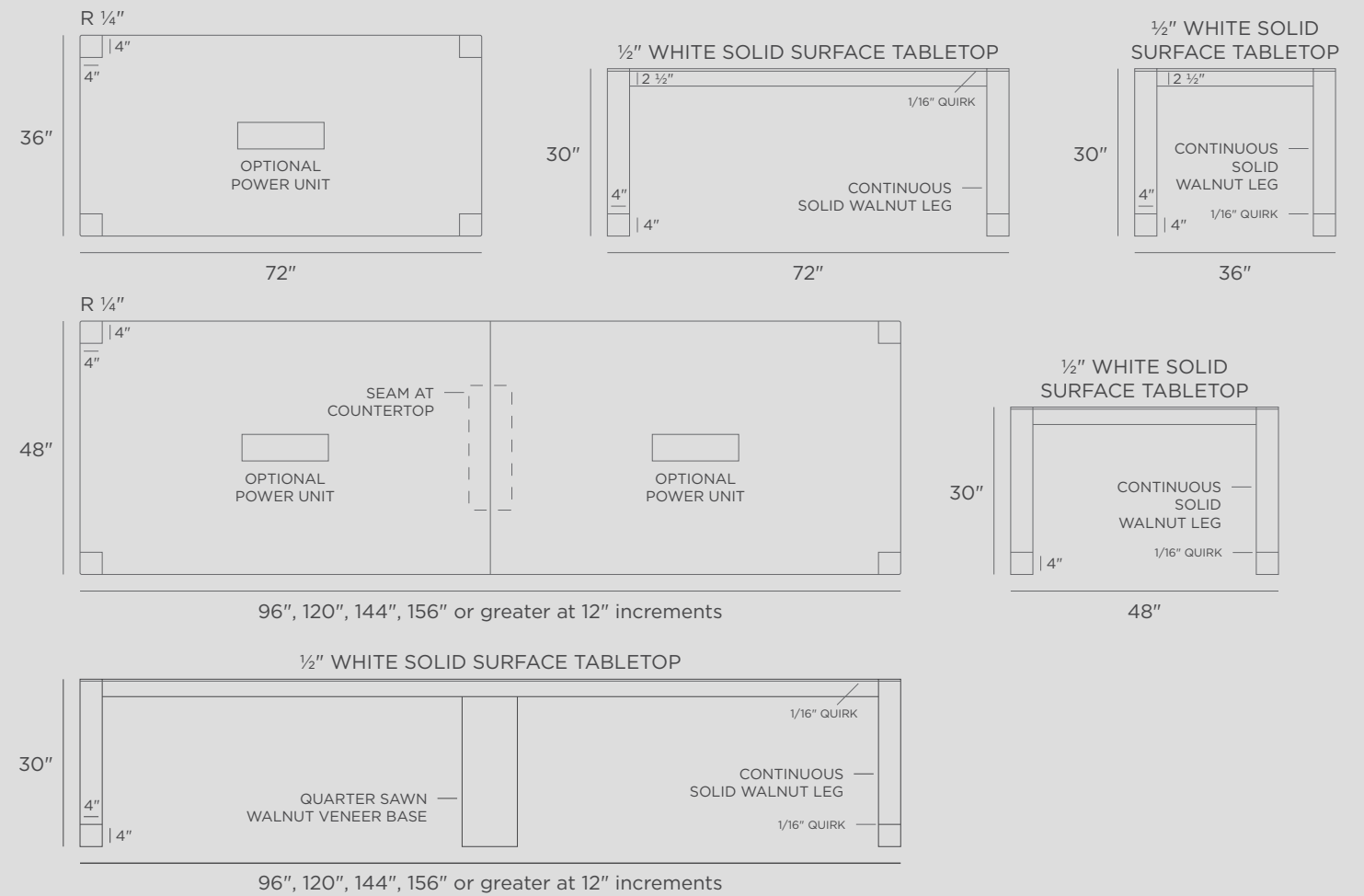
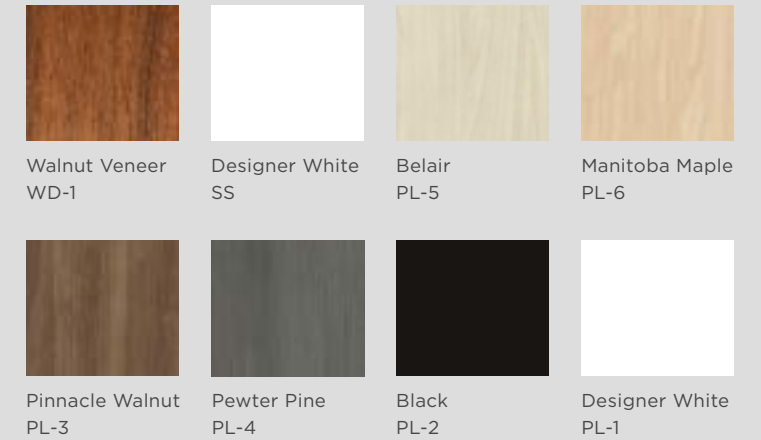

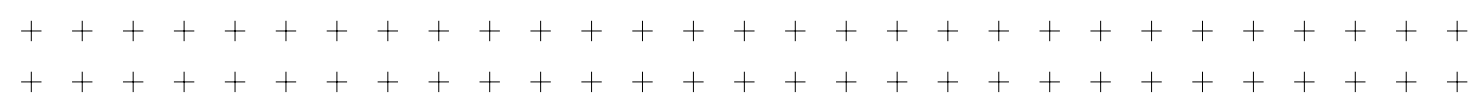
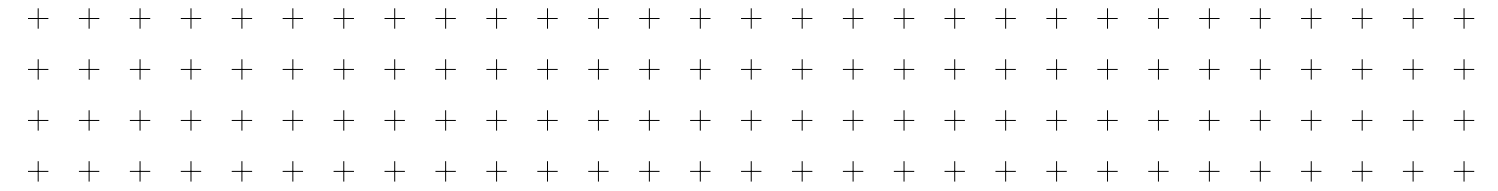

# TORINO CREDENZA

Boasting strength and elegance, the Torino Credenza complements the Torino Conference Table with its natural look and simplistic design. The Torino Credenza features four drawers and cabinets that offer plenty of space to tuck away meeting room necessities.

# TORINO CREDENZA



TORINO CREDENZA  
IN WALNUT VENEER



TORINO CREDENZA  
IN PEWTER PINE



TORINO CREDENZA  
IN BLACK

## LINEA BELLA



### + SPECIFICATION NOTES

✓ Solid surface (SS) finishes can be specified on any surface tops. Plastic laminate (PL) can be specified on any surface tops or bases.

Wood finish (WD) can only be specified for the bases.

● Credenzas are pre-assembled.

**SEE PRICING ON PAGE 45**

### + MATERIAL SPECIFICATIONS

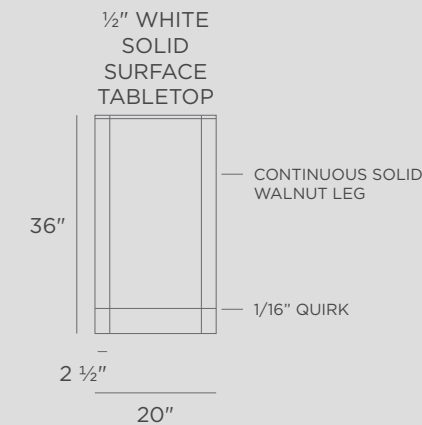
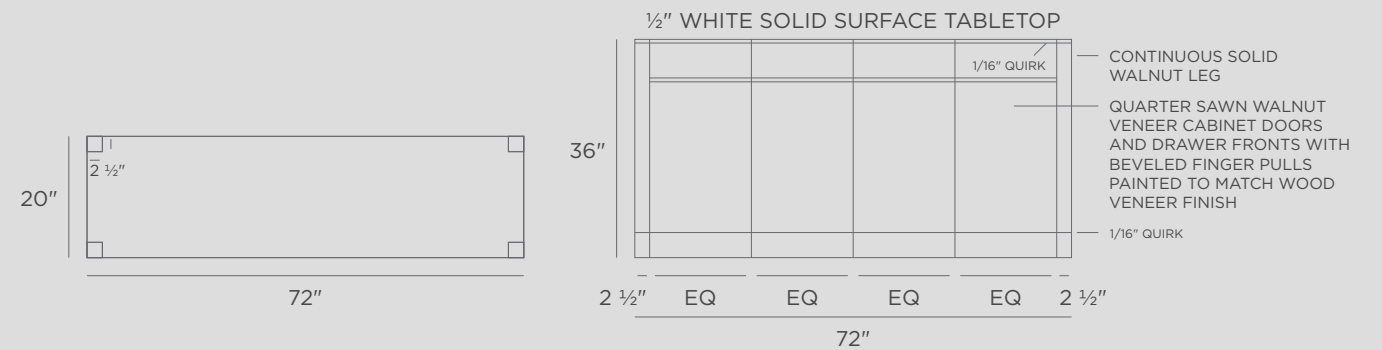
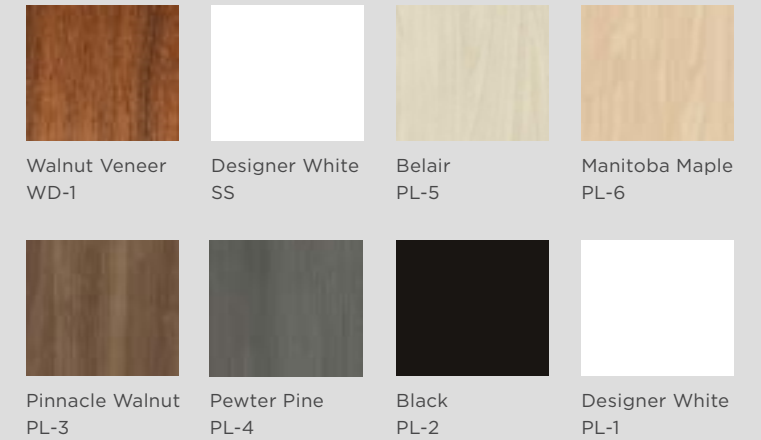

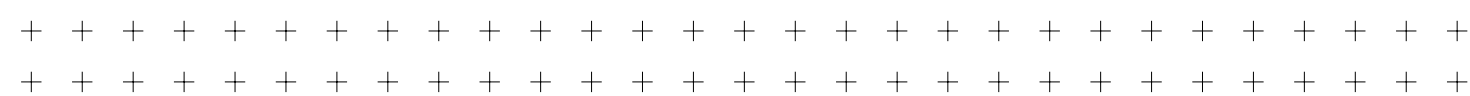
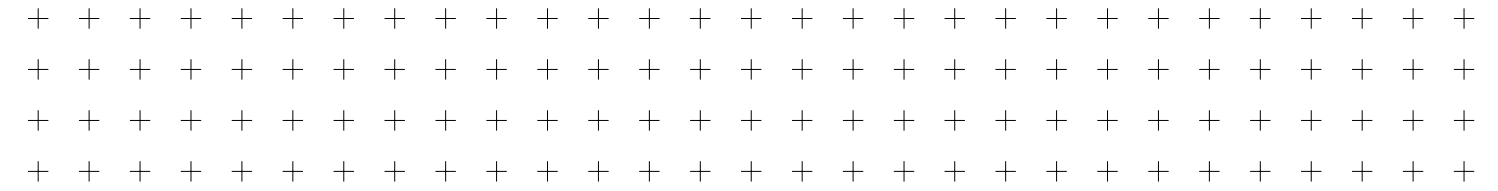

# VENICE CONFERENCE TABLE

Named after the City in the Sea, the Venice Conference Table cultivates community like no other. Built upon a traditional triangular-shaped H-base, a solid surface pours over the sides with softened, rounded edges reminiscent of an island in the canal. You'll be inspired to achieve great things when congregated around this beautiful table.

# VENICE CONFERENCE TABLE



VENICE CONFERENCE TABLE  
IN WALNUT VENEER



VENICE CONFERENCE TABLE  
IN PEWTER PINE



VENICE CONFERENCE TABLE  
IN BLACK

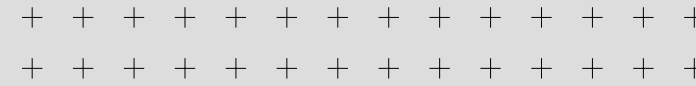

## + SPECIFICATION NOTES

✓ Solid surface (SS) finishes can be specified on any surface tops. Plastic laminate (PL) can be specified on any surface tops or bases.

Wood finish (WD) can only be specified for the bases.

● Tables ship knock-down. Assembly required.

SEE PRICING ON PAGE 46

## + MATERIAL SPECIFICATIONS

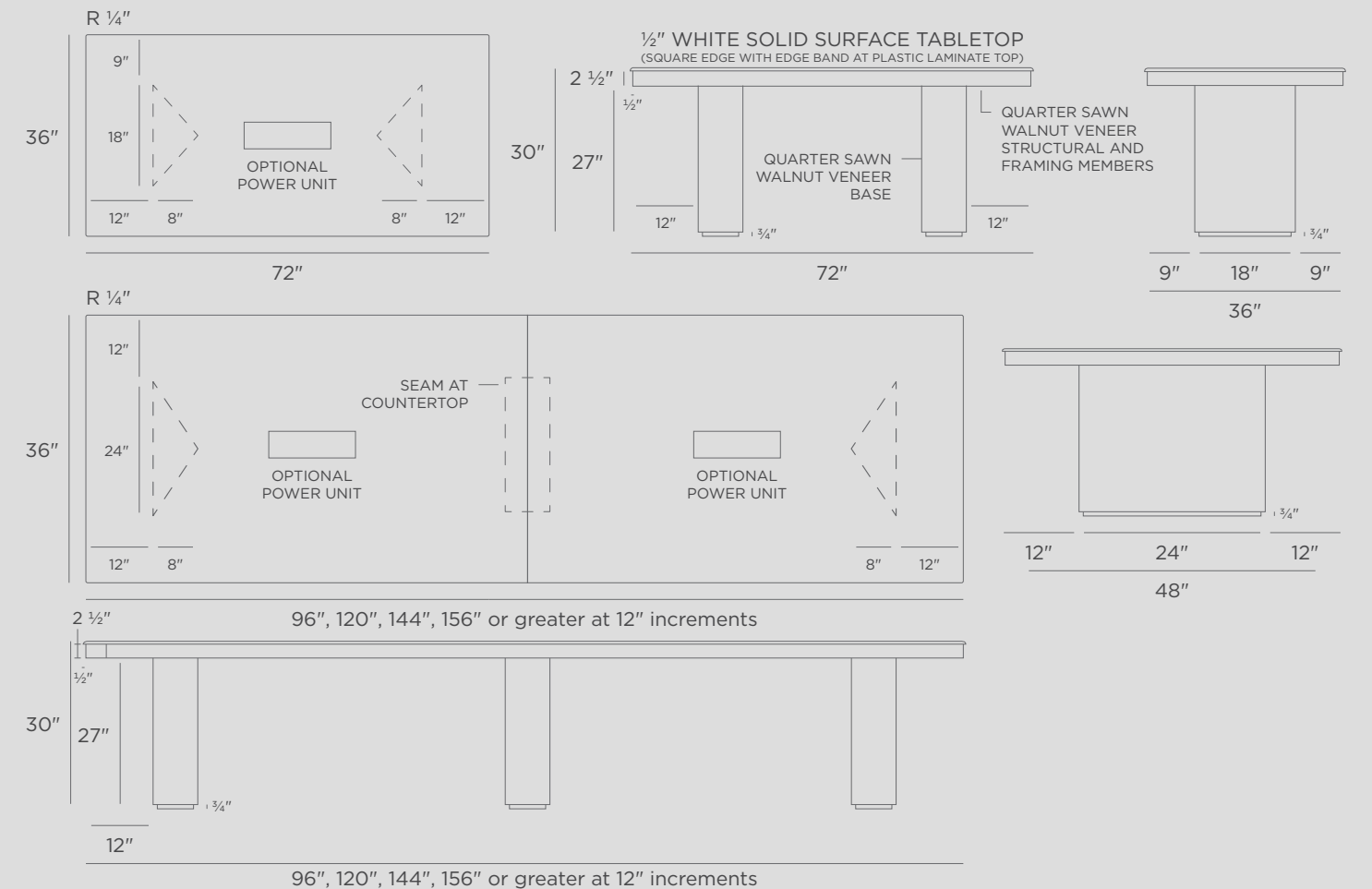
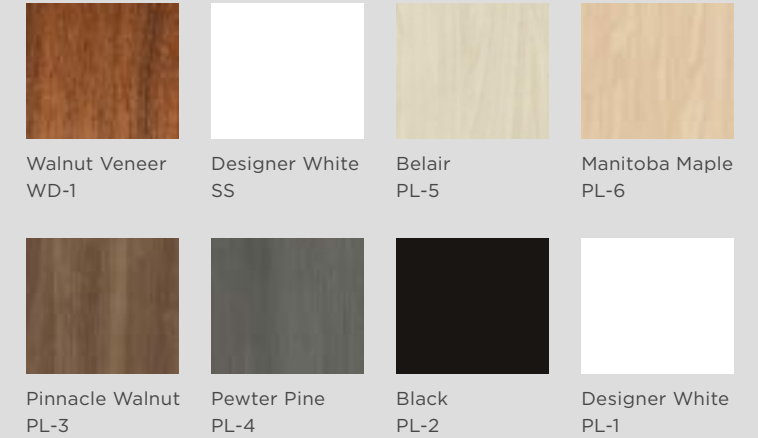



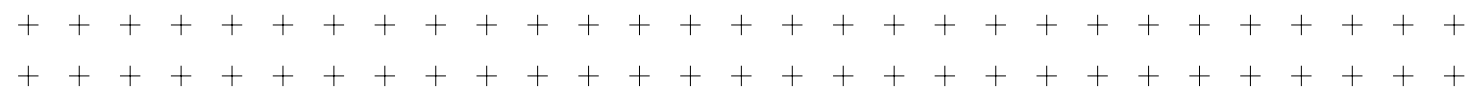
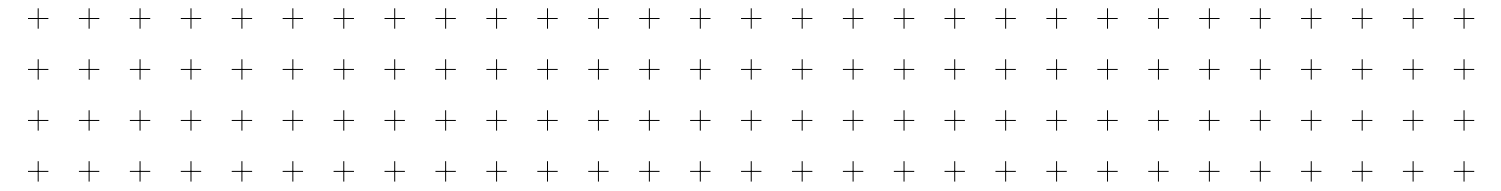

# VENICE CREDENZA

With a 1/2" solid surface reaching over from left to right like the many bridges of the canal, the Venice Credenza is the perfect complement to the Venice Conference Table. Boasting four cabinets and drawers with beveled finger pulls, this credenza delivers plenty of storage options for files and other meeting room needs.

# VENICE CREDENZA



VENICE CREDENZA  
IN WALNUT VENEER



VENICE CREDENZA  
IN PEWTER PINE



VENICE CREDENZA  
IN BLACK

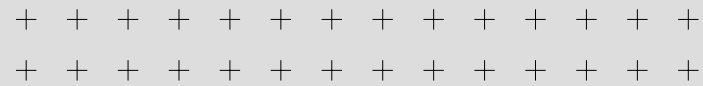

## + SPECIFICATION NOTES

✓ Solid surface (SS) finishes can be specified on any surface tops. Plastic laminate (PL) can be specified on any surface tops or bases.

Wood finish (WD) can only be specified for the bases.

● Credenzas are pre-assembled.

**SEE PRICING ON PAGE 47**

## + MATERIAL SPECIFICATIONS

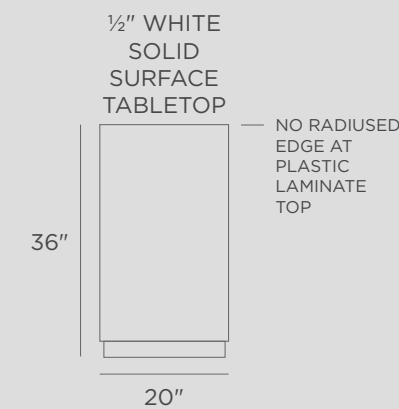
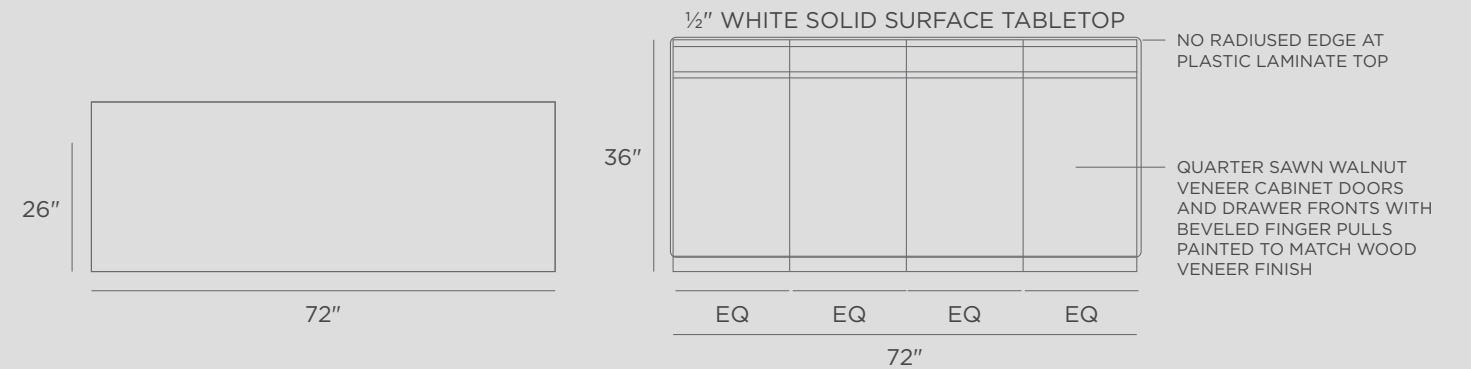
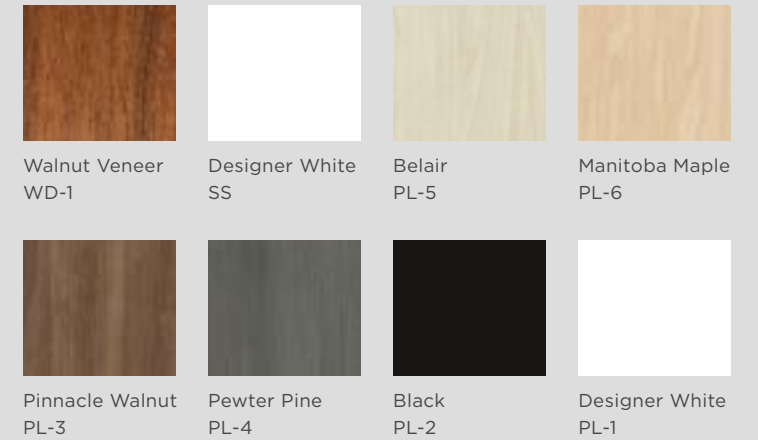

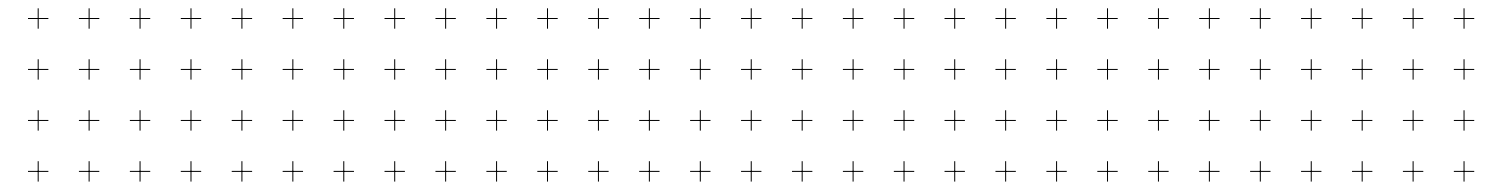

# PRICE GUIDE

# MILANO RECEPTION DESK

SKU	DESCRIPTION	DIMENSIONS	SURFACE MATERIAL	LIST PRICE
MR3496SSWD	RECEPTION DESK WITH 1/2"THK SOLID SURFACE WORKSURFACE SURFACE, TRANSACTION COUNTER AND END PANELS. BASES TO BE QUARTER SAWN WALNUT VENEER	8'-0"L X 2'-10D X 3'-6"H O.A.	"TOP: SS BASE: WD"	\$26,700
MR3496SSPL#	RECEPTION DESK WITH 1/2"THK SOLID SURFACE WORKSURFACE SURFACE, TRANSACTION COUNTER AND END PANELS. BASES TO BE PLASTIC LAMINATE.	8'-0"L X 2'-10D X 3'-6"H O.A.	"TOP: SS BASE: PLAM"	\$17,700
MR3496PL#PL#	RECEPTION DESK WITH 1/2"THK PLASTIC LAMINATE WORKSURFACE SURFACE, TRANSACTION COUNTER AND END PANELS. BASES TO BE PLASTIC LAMINATE.	8'-0"L X 2'-10D X 3'-6"H O.A.	"TOP: PLAM BASE: PLAM"	\$8,700
MR3412OSSWD	RECEPTION DESK WITH 1/2"THK SOLID SURFACE WORKSURFACE SURFACE, TRANSACTION COUNTER AND END PANELS. BASES TO BE QUARTER SAWN WALNUT VENEER	10'-0"L X 2'-10D X 3'-6"H O.A.	"TOP: SS BASE: WD"	\$33,200
MR3412OSSPL#	RECEPTION DESK WITH 1/2"THK SOLID SURFACE WORKSURFACE SURFACE, TRANSACTION COUNTER AND END PANELS. BASES TO BE PLASTIC LAMINATE.	10'-0"L X 2'-10D X 3'-6"H O.A.	"TOP: SS BASE: PLAM"	\$22,200
MR3412OPL#PL#	RECEPTION DESK WITH 1/2"THK PLASTIC LAMINATE WORKSURFACE SURFACE, TRANSACTION COUNTER AND END PANELS. BASES TO BE PLASTIC LAMINATE.	10'-0"L X 2'-10D X 3'-6"H O.A.	"TOP: PLAM BASE: PLAM"	\$11,200
MR34(LENGTH)SSWD	RECEPTION DESK WITH 1/2"THK SOLID SURFACE WORKSURFACE SURFACE, TRANSACTION COUNTER AND END PANELS. BASES TO BE QUARTER SAWN WALNUT VENEER	12'-0"L X 2'-10D X 3'-6"H O.A.	"TOP: SS BASE: WD"	\$40,000
MR34(LENGTH)SSPL#	RECEPTION DESK WITH 1/2"THK SOLID SURFACE WORKSURFACE SURFACE, TRANSACTION COUNTER AND END PANELS. BASES TO BE PLASTIC LAMINATE.	12'-0"L X 2'-10D X 3'-6"H O.A.	"TOP: SS BASE: PLAM"	\$26,000
MR34(LENGTH)PL#PL#	RECEPTION DESK WITH 1/2"THK PLASTIC LAMINATE WORKSURFACE SURFACE, TRANSACTION COUNTER AND END PANELS. BASES TO BE PLASTIC LAMINATE.	12'-0"L X 2'-10D X 3'-6"H O.A.	"TOP: PLAM BASE: PLAM"	\$13,000

SPECIFY PLACEMENT OF TRANSACTION COUNTER. LEFT, RIGHT OR CENTER

# SALERNO COLLABORATIVE TABLE

## MILANO STORAGE OPTIONS

SKU	DESCRIPTION	DIMENSIONS	SURFACE MATERIAL	LIST PRICE
BB18WD	UNDERSURFACE BOX/BOX/FILE CABINET IN QUARTER SAWN WALNUT VENEER	1'-6"W X 1'-11"D X 2'-3 5/8"H	WD	\$1,500
BB18PL#	UNDERSURFACE BOX/BOX/FILE CABINET IN PLASTIC LAMINATE	1'-6"W X 1'-11"D X 2'-3 5/8"H	PLAM	\$925
FF18WD	UNDERSURFACE FILE/FILE CABINET IN QUARTER SAWN WALNUT VENEER	1'-6"W X 1'-11"D X 2'-3 5/8"H	WD	\$1,500
FF18PL#	UNDERSURFACE FILE/FILE CABINET IN PLASTIC LAMINATE	1'-6"W X 1'-11"D X 2'-3 5/8"H	PLAM	\$925
LF36WD	UNDERSURFACE LATERAL FILE CABINET IN QUARTER SAWN WALNUT VENEER	3'-0"W X 1'-11"D X 2'-3 5/8"H	WD	\$1,600
LF36PL#	UNDERSURFACE LATERAL FILE CABINET IN PLASTIC LAMINATE	3'-0"W X 1'-11"D X 2'-3 5/8"H	PLAM	\$1,275

SKU	DESCRIPTION	DIMENSIONS	SURFACE MATERIAL	LIST PRICE
SC3696SSWD	TABLE TOP, 1/2" THK SOLID SURFACE WITH RADIUSED EDGE AND FINISHED END PANELS. QUARTER SAWN WALNUT VENEER STRUCTURE	8'-0"L X 3'-0"W X 42"H	"TOP/END PANELS: SS STRUCTURE: WD"	\$19,200
SC3696SSPL#	TABLE TOP, 1/2" THK SOLID SURFACE WITH RADIUSED EDGE AND FINISHED END PANELS. PLASTIC LAMINATE STRUCTURE	8'-0"L X 3'-0"W X 42"H	"TOP/END PANELS: SS STRUCTURE: PLAM"	\$12,800
SC3696PL#PL#	TABLE TOP, 1/2" THK PLASTIC LAMINATE WITH SQUARE EDGE AND FINISHED END PANELS. PLASTIC LAMINATE STRUCTURE	8'-0"L X 3'-0"W X 42"H	"TOP/END PANELS: PLAM STRUCTURE: PLAM"	\$6,800
SC36120SSWD	TABLE TOP, 1/2" THK SOLID SURFACE WITH RADIUSED EDGE AND FINISHED END PANELS. QUARTER SAWN WALNUT VENEER STRUCTURE	10'-0"L X 3'-0"W X 42"H	"TOP/END PANELS: SS STRUCTURE: WD"	\$22,800
SC36120SSPL#	TABLE TOP, 1/2" THK SOLID SURFACE WITH RADIUSED EDGE AND FINISHED END PANELS. PLASTIC LAMINATE STRUCTURE	10'-0"L X 3'-0"W X 42"H	"TOP/END PANELS: SS STRUCTURE: PLAM"	\$15,200
SC36120PL#PL#	TABLE TOP, 1/2" THK PLASTIC LAMINATE WITH SQUARE EDGE AND FINISHED END PANELS. PLASTIC LAMINATE STRUCTURE	10'-0"L X 3'-0"W X 42"H	"TOP/END PANELS: PLAM STRUCTURE: PLAM"	\$7,800
SC36144SSWD	TABLE TOP, 1/2" THK SOLID SURFACE WITH RADIUSED EDGE AND FINISHED END PANELS. QUARTER SAWN WALNUT VENEER STRUCTURE	12'-0"L X 3'-0"W X 42"H	"TOP/END PANELS: SS STRUCTURE: WD"	\$26,800
SC36144SSPL#	TABLE TOP, 1/2" THK SOLID SURFACE WITH RADIUSED EDGE AND FINISHED END PANELS. PLASTIC LAMINATE STRUCTURE	12'-0"L X 3'-0"W X 42"H	"TOP/END PANELS: SS STRUCTURE: PLAM"	\$17,800
SC36144PL#PL#	TABLE TOP, 1/2" THK PLASTIC LAMINATE WITH SQUARE EDGE AND FINISHED END PANELS. PLASTIC LAMINATE STRUCTURE	12'-0"L X 3'-0"W X 42"H	"TOP/END PANELS: PLAM STRUCTURE: PLAM"	\$8,800

# TORINO CONFERENCE TABLE

SKU	DESCRIPTION	DIMENSIONS	SURFACE MATERIAL	LIST PRICE
TT3672SSWD	TABLE TOP, 1/2"THK SOLID SURFACE TABLE TOP WITH QUARTER SAWN WALNUT LEGS AND APRON	6'-0"L X 3'-0"W	"TOP:SS LEGS: WD"	\$9,700
TT3672SSPL#	TABLE TOP, 1/2"THK SOLID SURFACE TABLE TOP WITH PLASTIC LAMINATE LEGS AND APRON	6'-0"L X 3'-0"W	"TOP:SS LEGS: PLAM"	\$6,700
TT3672PL#PL#	TABLE TOP, 1/2"THK PLASTIC LAMINATE TABLE TOP WITH PLASTIC LAMINATE LEGS AND APRON	6'-0"L X 3'-0"W	"TOP:PLAM LEGS: PLAM"	\$3,700
TT3696SSWD	TABLE TOP, 1/2"THK SOLID SURFACE TABLE TOP WITH QUARTER SAWN WALNUT LEGS AND APRON	8'-0"L X 4'-0"W	"TOP:SS LEGS: WD"	\$17,200
TT3696SSPL#	TABLE TOP, 1/2"THK SOLID SURFACE TABLE TOP WITH PLASTIC LAMINATE LEGS AND APRON	8'-0"L X 4'-0"W	"TOP:SS LEGS: PLAM"	\$11,200
TT3696PL#PL#	TABLE TOP, 1/2"THK PLASTIC LAMINATE TABLE TOP WITH PLASTIC LAMINATE LEGS AND APRON	8'-0"L X 4'-0"W	"TOP:PLAM LEGS: PLAM"	\$5,700
TT36120SSWD	TABLE TOP, 1/2"THK SOLID SURFACE TABLE TOP WITH QUARTER SAWN WALNUT LEGS AND APRON	10'-0"L X 4'-0"W	"TOP:SS LEGS: WD"	\$21,200
TT36120SSPL#	TABLE TOP, 1/2"THK SOLID SURFACE TABLE TOP WITH PLASTIC LAMINATE LEGS AND APRON	10'-0"L X 4'-0"W	"TOP:SS LEGS: PLAM"	\$14,200
TT36120PL#PL#	TABLE TOP, 1/2"THK PLASTIC LAMINATE TABLE TOP WITH PLASTIC LAMINATE LEGS AND APRON	10'-0"L X 4'-0"W	"TOP:PLAM LEGS: PLAM"	\$7,200
TT36144SSWD	TABLE TOP, 1/2"THK SOLID SURFACE TABLE TOP WITH QUARTER SAWN WALNUT LEGS AND APRON	12'-0"L X 4'-0"W	"TOP:SS LEGS: WD"	\$25,800
TT36144SSPL#	TABLE TOP, 1/2"THK SOLID SURFACE TABLE TOP WITH PLASTIC LAMINATE LEGS AND APRON	12'-0"L X 4'-0"W	"TOP:SS LEGS: PLAM"	\$17,800
TT36144PL#PL#	TABLE TOP, 1/2"THK PLASTIC LAMINATE TABLE TOP WITH PLASTIC LAMINATE LEGS AND APRON	12'-0"L X 4'-0"W	"TOP:PLAM LEGS: PLAM"	\$8,800
TT36(LENGTH)SSWD	TABLE TOP, 1/2"THK SOLID SURFACE TABLE TOP WITH QUARTER SAWN WALNUT LEGS AND APRON. INCLUDES CENTER H-BASE	(CUSTOM) L X 4'-0"W	"TOP:SS LEGS: WD"	CALL FOR PRICE
TT36(LENGTH)SSPL#	TABLE TOP, 1/2"THK SOLID SURFACE TABLE TOP WITH PLASTIC LAMINATE LEGS AND APRON. INCLUDES CENTER H-BASE	(CUSTOM) L X 4'-0"W	"TOP:SS LEGS: PLAM"	CALL FOR PRICE
TT36(LENGTH)PL#PL#	TABLE TOP, 1/2"THK PLASTIC LAMINATE TABLE TOP WITH PLASTIC LAMINATE LEGS AND APRON. INCLUDES CENTER H-BASE	(CUSTOM) L X 4'-0"W	"TOP:PLAM LEGS: PLAM"	CALL FOR PRICE

# TORINO CREDENZA

SKU	DESCRIPTION	DIMENSIONS	SURFACE MATERIAL	LIST PRICE
TC2072SSWD	CREDENZA WITH 1/2"THK SOLID SURFACE COUNTERTOP AND WOOD VENEER BASE CABINETS WITH (1) DOOR AND (1) DRAWER	6'-0"W X 20"D X 36"H	"TOP:SS BASE: WD"	\$10,500
TC2072SSPL#	CREDENZA WITH 1/2"THK SOLID SURFACE COUNTERTOP AND PLASTIC LAMINATE BASE CABINETS WITH (1) DOOR AND (1) DRAWER	6'-0"W X 20"D X 36"H	"TOP:SS BASE: PLAM"	\$6,800
TC2072PL#PL#	CREDENZA WITH 1/2"THK PLASTIC LAMINATE COUNTERTOP AND PLASTIC LAMINATE BASE CABINETS WITH (1) DOOR AND (1) DRAWER	6'-0"W X 20"D X 36"H	"TOP:PLAM BASE: PLAM"	\$3,600
TC2096SSWD	CREDENZA WITH 1/2"THK SOLID SURFACE COUNTERTOP AND WOOD VENEER BASE CABINETS WITH (1) DOOR AND (1) DRAWER	8'-0"W X 20"D X 36"H	"TOP:SS BASE: WD"	\$1,400
TC2096SSPL#	CREDENZA WITH 1/2"THK SOLID SURFACE COUNTERTOP AND PLASTIC LAMINATE BASE CABINETS WITH (1) DOOR AND (1) DRAWER	8'-0"W X 20"D X 36"H	"TOP:SS BASE: PLAM"	\$9,200
TC2096PL#PL#	CREDENZA WITH 1/2"THK PLASTIC LAMINATE COUNTERTOP AND PLASTIC LAMINATE BASE CABINETS WITH (1) DOOR AND (1) DRAWER	8'-0"W X 20"D X 36"H	"TOP:PLAM BASE: PLAM"	\$4,600

# VENICE CONFERENCE TABLE

SKU	DESCRIPTION	DIMENSIONS	SURFACE MATERIAL	LIST PRICE
VT3672SSWD	TABLE TOP WITH 1/2"THK SOLID SURFACE WITH RADIUS EDGE AND FINISHED END PANELS, QUARTER SAWN WALNUT APRON AND (2) TRIANGULAR H-BASES	6'-0"L X 3'-0"W	"TOP/END PANELS: SS BASE: WD"	\$12,600
VT3672SSPL#	TABLE TOP WITH 1/2"THK SOLID SURFACE WITH RADIUS EDGE AND FINISHED END PANELS, PLASTIC LAMINATE APRON AND (2) TRIANGULAR H-BASES	6'-0"L X 3'-0"W	"TOP/END PANELS: SS BASE: PLAM"	\$8,400
VT3672PL#PL#	TABLE TOP WITH 1/2"THK PLASTIC LAMINATE WITH SQUARE EDGE AND FINISHED END PANELS, PLASTIC LAMINATE APRON AND (2) TRIANGULAR H-BASES	6'-0"L X 3'-0"W	"TOP/END PANELS: PLAM BASE: PLAM"	\$4,400
VT3696SSWD	TABLE TOP WITH 1/2"THK SOLID SURFACE WITH RADIUS EDGE AND FINISHED END PANELS, QUARTER SAWN WALNUT APRON AND (2) TRIANGULAR H-BASES	8'-0"L X 4'-0"W	"TOP/END PANELS: SS BASE: WD"	\$16,800
VT3696SSPL#	TABLE TOP WITH 1/2"THK SOLID SURFACE WITH RADIUS EDGE AND FINISHED END PANELS, PLASTIC LAMINATE APRON AND (2) TRIANGULAR H-BASES	8'-0"L X 4'-0"W	"TOP/END PANELS: SS BASE: PLAM"	\$11,200
VT3696PL#PL#	TABLE TOP WITH 1/2"THK PLASTIC LAMINATE WITH SQUARE EDGE AND FINISHED END PANELS, PLASTIC LAMINATE APRON AND (2) TRIANGULAR H-BASES	8'-0"L X 4'-0"W	"TOP/END PANELS: PLAM BASE: PLAM"	\$5,800
VT36120SSWD	TABLE TOP WITH 1/2"THK SOLID SURFACE WITH RADIUS EDGE AND FINISHED END PANELS, QUARTER SAWN WALNUT APRON AND (2) TRIANGULAR H-BASES	10'-0"L X 4'-0"W	"TOP/END PANELS: SS BASE: WD"	\$19,800
VT36120SSPL#	TABLE TOP WITH 1/2"THK SOLID SURFACE WITH RADIUS EDGE AND FINISHED END PANELS, PLASTIC LAMINATE APRON AND (2) TRIANGULAR H-BASES	10'-0"L X 4'-0"W	"TOP/END PANELS: SS BASE: PLAM"	\$13,200
VT36120PL#PL#	TABLE TOP WITH 1/2"THK PLASTIC LAMINATE WITH SQUARE EDGE AND FINISHED END PANELS, PLASTIC LAMINATE APRON AND (2) TRIANGULAR H-BASES	10'-0"L X 4'-0"W	"TOP/END PANELS: PLAM BASE: PLAM"	\$6,800
VT36144SSWD	TABLE TOP WITH 1/2"THK SOLID SURFACE WITH RADIUS EDGE AND FINISHED END PANELS, QUARTER SAWN WALNUT APRON AND (2) TRIANGULAR H-BASES	12'-0"L X 4'-0"W	"TOP/END PANELS: SS BASE: WD"	\$22,800
VT36144SSPL#	TABLE TOP WITH 1/2"THK SOLID SURFACE WITH RADIUS EDGE AND FINISHED END PANELS, PLASTIC LAMINATE APRON AND (2) TRIANGULAR H-BASES	12'-0"L X 4'-0"W	"TOP/END PANELS: SS BASE: PLAM"	\$15,800

# VENICE CONFERENCE TABLE (CONT.)

VT36144PL#PL#	TABLE TOP WITH 1/2"THK PLASTIC LAMINATE WITH SQUARE EDGE AND FINISHED END PANELS, PLASTIC LAMINATE APRON AND (2) TRIANGULAR H-BASES	12'-0"L X 4'-0"W	"TOP/END PANELS: PLAM BASE: PLAM"	\$7,800
VT36(LENGTH) SSWD	TABLE TOP WITH 1/2"THK SOLID SURFACE WITH RADIUS EDGE AND FINISHED END PANELS, QUARTER SAWN WALNUT APRON, (2) TRIANGULAR H-BASES AND (1) DIAMOND SHAPED CENTER H-BASE	(CUSTOM) L X 4'-0"W	"TOP/END PANELS: SS BASE: WD"	CALL FOR PRICE
VT36(LENGTH) SSPL#	TABLE TOP WITH 1/2"THK SOLID SURFACE WITH RADIUS EDGE AND FINISHED END PANELS, PLASTIC LAMINATE APRON, (2) TRIANGULAR H-BASES AND (1) DIAMOND SHAPED CENTER H-BASE	(CUSTOM) L X 4'-0"W	"TOP/END PANELS: SS BASE: PLAM"	CALL FOR PRICE
VT36(LENGTH) PL#PL#	TABLE TOP WITH 1/2"THK PLASTIC LAMINATE WITH SQUARE EDGE AND FINISHED END PANELS, PLASTIC LAMINATE APRON, (2) TRIANGULAR H-BASES AND (1) DIAMOND SHAPED CENTER H-BASE	(CUSTOM) L X 4'-0"W	"TOP/END PANELS: PLAM BASE: PLAM"	CALL FOR PRICE

# VENICE CREDENZA

SKU	DESCRIPTION	DIMENSIONS	SURFACE MATERIAL	LIST PRICE
VC2072SSWD	CREDENZA WITH 1/2"THK SOLID SURFACE WITH RADIUS EDGE AND FINISHED END PANELS, QUARTER SAWN WALNUT VENEER BASE CABINETS WITH (1) DOOR AND (1) DRAWER	6'-0"W X 20"D X 36"H	"TOP/END PANELS: SS BASE: WD"	\$12,500
VC2072SSPL#	CREDENZA WITH 1/2"THK SOLID SURFACE WITH RADIUS EDGE AND FINISHED END PANELS, PLASTIC LAMINATE BASE CABINETS WITH (1) DOOR AND (1) DRAWER	6'-0"W X 20"D X 36"H	"TOP/END PANELS: SS BASE: PLAM"	\$8,500
VC2072PL#PL#	CREDENZA WITH 1/2"THK PLASTIC LAMINATE WITH SQUARE EDGE AND FINISHED END PANELS, PLASTIC LAMINATE BASE CABINETS WITH (1) DOOR AND (1) DRAWER	6'-0"W X 20"D X 36"H	"TOP/END PANELS: PLAM BASE: PLAM"	\$4,500
VC2096SSWD	CREDENZA WITH 1/2"THK SOLID SURFACE WITH RADIUS EDGE AND FINISHED END PANELS, QUARTER SAWN WALNUT VENEER BASE CABINETS WITH (1) DOOR AND (1) DRAWER	8'-0"W X 20"D X 36"H	"TOP/END PANELS: SS BASE: WD"	\$16,500
VC2096SSPL#	CREDENZA WITH 1/2"THK SOLID SURFACE WITH RADIUS EDGE AND FINISHED END PANELS, PLASTIC LAMINATE BASE CABINETS WITH (1) DOOR AND (1) DRAWER	8'-0"W X 20"D X 36"H	"TOP/END PANELS: SS BASE: PLAM"	\$11,500
VC2096PL#PL#	CREDENZA WITH 1/2"THK PLASTIC LAMINATE WITH SQUARE EDGE AND FINISHED END PANELS, PLASTIC LAMINATE BASE CABINETS WITH (1) DOOR AND (1) DRAWER	8'-0"W X 20"D X 36"H	"TOP/END PANELS: PLAM BASE: PLAM"	\$5,500



# MADE TO MEASURE. BUILT TO SUIT.

**Chicago Office**

One Prudential Plaza  
130 E Randolph St, Suite 2050  
Chicago, IL 60601

**Forest Park Office / Manufacturing**

7540 Roosevelt Rd  
Forest Park, IL 60130

**Kris Imala**

CEO, Managing Principal & Majority Owner  
kimala@customcrafterschicago.com  
m: 312.590.7808

**Paul Kelly**

President  
paulk@customcrafterschicago.com  
m: 773.617.8408

Designed By Nick Poblador +  
Custom Crafters Team

[customcrafterschicago.com](http://customcrafterschicago.com)

+ + + + + + + + + + + + + + +

