



customcrafters

(708) 546-5841

7540 W Roosevelt Rd, Forest Park, IL 60130
customcrafterschicago.com

Catalog 2023
10-01-23

Specifications

- LP (Thermal Fused Laminate) - 1-1/8" thick.
- HP (High Pressure Laminate) - 1-1/4" thick.
- PolyBak on the underside.
- Edgebanding on all sides.
- Sizes value at 'True Dimensions' unless otherwise specified.
- For a (2) piece top, add \$100 List for spline joint and tight joint fastener.
- Add \$220 List for (2) anti-sag bars.
- Use with Supports on page 34.
- All Custom Crafters furniture is shipped fully assembled, unless otherwise noted.
- Custom Crafters is manufactured using scratch, spill and stain resistant high pressure laminate (HP) or Thermal Fused Laminate (LP). See page 66 for a listing of our standard laminate colors.
- Custom Crafters uses M-3 CARB2 compliant industrial grade particleboard for all furniture with moisture resistant PolyBak on the underside.
- Custom sizes are available. Please contact customer service for pricing and availability.
- Desk includes 6" recessed full modesty panel and locks.
- Pedestal drawers operate on precision full extension slides. Hang rails are provided in all file drawers for front-to-back letter filing.
- Edge is 2mm PVC. See page 67 for colors.
- Full pedestals are 16-1/4"Wx23"Lx27-5/8"H.
- 3/4 pedestals are 16-1/4"Wx23"Lx18-1/2"H.
- Lateral files are 36"Wx23"Lx27-5/8"H.
- Pedestal drawers operate on precision full extension slides. Hang rails are provided in all file drawers for front-to-back letter filing.
- Storage cabinets include adjustable shelves and non-locking doors.
- Grommet Cutouts are 2-1/2" in diameter and are placed 3-1/2" on center away from the inner panel.
- Grommets are \$26 List each.
- Scallops are 7" x 1-1/2".
- Scallops are \$40 List each.

Rotating Power Unit Specifications

- Finish comes in Satin Aluminum or Matte Black.
- Standard electric cord available in 6 foot and 12 foot lengths. Custom lengths also available upon request. Additional leadtime will be applied for 12 foot or custom lengths of electric cord.
- Chicago code option available.
- Safety Photo Electric Eye prevents rotation when obstructed.
- UL CUL SE Approved
- Spill Test Approved
- Quality Inspected
- 2-year Warranty
- Additional leadtime will be applied for custom ports. Please contact customer service for pricing and availability.

Overview

- Ordering information 6
- Warranty 7
- Terms and Condition 8
- Need to know 10

Grommets & Scallops

- Grommets 11
- Scallops 11

Work Surfaces

- Square Corner Rectangle (WSS) 12
- Radius Corner Rectangle (WSR) 14
- Extended Corner (ECSL/ECSR) 16
- Extended Corner with Radius (ECRL/ECRR) 20
- Straight Corner (SCS) 24
- Straight Corner with Radius (SCR) 24
- Curved Corner (CCS) 24
- Curved Corner with Radius (CCR) 24
- Quarter Round Corner (QRS) 25
- Quarter Round Corner with Radius (QRR) 25
- Half-Round Corner (HRS) 26
- Half-Round Corner with Radius (HRR) 26
- Transition Top (TTSL/TTSR) 27
- Transition Top with Radius (TTRL/TTRR) 27
- D-Top (DTS) 28
- D-Top with Radius (DTR) 28
- Arc Top (ATS) 29
- Arc Top with Radius (ATR) 29
- P-Top (PTSL/PTSR) 30
- P-Top with Radius (PTSL/PTSR) 31
- Corner D-Top (CDSL/CDSR) 32
- Corner D-Top with Radius (CDRL/CDRR) 32
- Corner P-Top (CPSL/CPSR) 33
- Corner P-Top with Radius (CPRL/CPRR) 33

Supports

- Rectangle Support (RS) 34
- Curved Support (CS) 34
- T Support (TS) 34
- Modesty Panel Support (MP) 35
- L Support (LSL/LSR) 35

Table Tops

- Square Table Tops (SQT) 36
- Round Table Tops (RDT) 36
- Training Table Tops (TTT) 36
- Rectangle Table Top (RTT) 37
- Radius Corner Table Tops (RCT) 37
- Oval Table Tops (OTT) 38
- Racetrack Table Tops (RCK) 38
- Boat Shape Table Tops (BTT) 38

Tables Seating Capacity

- Table Seating Capacity 39

Occasional Tables

- **Occasional Tables** 40
 - Cube Table (OTC)
 - Cube Table with Base (OTCB)
 - Drum Table (OTD)
 - Drum Table with Base (OTDB)

Bases

- H Base (HB) 42
- X Base (XB) 42
- Box H Base (BHB) 43
- Drum Base (DB) 43

Typicals

- Typical 1-6 44

Desks

- Rectangle Desks (RD) 46
- Bow Front Desks (BD) 47

Desk Returns

- Returns (DR) 48

Reception

- **Reception Options** 49
 - Front (RF)
 - Panel Front (PF)
 - Clear Glass Top (CGT)
 - Frosted Glass Top (FGT)

Peninsula Desks

- **Peninsula Desks** 50
 - Square Top (STK)
 - D-Top (DTK)
 - Arc Top (ATK)
 - Corner D-Top (CDKL/CDKR)
 - Corner P-Top (CPKL/CPKR)

Credenza

- Credenza (CDZ) 52
- Storage & Filing**
- **Hutch and Wall Mounted Storage** 54
 - Hutch (H)
 - Wall Mounted Storage Cabinets (WM)
- **Lateral Files**
 - Undersurface Lateral Files without Finish Top (LF)
 - Freestanding Lateral Files with Two Drawers (LFT2)
 - Lateral Files with Four Drawers (LFT4)
- **Pedestal** 55
 - Pedestal without Tops (BBF/FF)
 - Pedestal with Finish Top (BBFT/FFT)
 - Mobile Pedestal with Cushion Top (BFM)
- **Storage**
 - Storage Cabinet without Finish Top (HD)
 - Storage Cabinet with Finish Top (HDT)
 - Low Storage Unit (LOSL/LOSR)
 - Bookcases (BK/BKD)
 - Locker Unit (LK1/LK2)
 - Storage Cabinet (SCB)
 - Wardrobe Storage Cabinet (WD)
 - Storage Cabinet Combo 1 (SCC-1)
 - Storage Cabinet Combo 2 (SCC-2)
 - Storage Cabinet with Lateral File (SLF)

Accessories

- **Rotating Power Unit** 58
 - Conference Table Power Unit (CPU)
 - Training Table Power Unit (TPU)
 - Desk Power Unit (DPU)
 - Ports
- **Tackboard (TB)** 60
- **Laminate Whiteboard**
 - T-Mould (TML)
 - Maple Frame (MFL)
- **Glass Whiteboard** 61
 - Standard (GWB01)
 - Starphire (GWB02)
- Hardware**
- **Hardwares** 62
 - Grommet Cover (GROMMET)
 - Angle Mounting Bracket (AMB)
 - Leveler (LVR)
 - Threaded Insert (TIN)
 - Aluminium Cylinder Leg (J11806)
 - Mending Plates (MP1/MP2/MP3)
 - Tight Joint Fastner (76-03-020)
 - Haworth Worksurface Support Bracket (CH-WSBKT-L/ CH-WSBKT-R)

Pulls

- Standard Pulls (P1-P8) 64

Edge Profile

- Self Edge (S1/S2) 65
- T-Mold (TM)

Finishes

- **Thermally Fused Laminate Colors (LP)** 66
 - White (W100)
 - Beige / Wallaby (D439)
 - Graytone / Shadow (U235)
 - Smoke / Dark Grey (U204)
 - Cabinet Maple (WF270)
 - Harvest Cherry (WF276)
 - Ankara Cherry (WF236)
 - Brazillian (WF 220)
 - Cherry Hill Plank (WF230)
- **HP Standard Laminate Color**
- **Edgeband Color** 67
 - White
 - Beige / Wallaby
 - Graytone / Shadow
 - Smoke / Dark Grey
 - Graphite
 - Black
 - Fusion Maple
 - Summer Flame
 - Shaker Cherry
 - Acajou Mahogany
 - Shadow Oak

How to Order

Each Page has a How to Order chart. Please refer to the chart and follow the steps to build your model number.

Custom Sizes

Use the next size up for pricing and specify the size needed on the purchase order.

Small Orders

Add \$75 net to any high pressure worksurfaces orders with fewer than 3 tops.

Freight Term

F.O.B Custom Crafters' warehouse. For delivery, please call for pricing and crating charges.

Payment Term

Net 30 days.

Order Confirmations

All purchase orders will be confirmed within 1-2 business days of receipt. If you do not receive your confirmation, please contact customer service to ensure the order was received.

Taxes

Purchaser is responsible for all local, state and federal taxes and usage fees. Tax-exempt certificate must be submitted when the account is established.

Order Changes and Cancellations

All changes and cancellations must be submitted in writing. Changes may result in longer lead times. Purchaser is responsible for the full value of material and labor that is procured for an order that is cancelled or changed.

Manufacturing Details

All parts are manufactured using M-3 CARB2 compliant industrial grade particleboard unless otherwise specified.

All Parts include PolyBak on the underside of the part. PolyBak is superior to a paper backer because it offers a better balanced panel and is moisture resistant.

Custom Crafters uses a cold-press laminating system which bonds the laminate to the particleboard using a rigid PVA glue line. This is superior to contact cement since it provides a true bond between the materials. This method of laminating virtually eliminates the possibility of delamination.

Warranty

Custom Crafters promises to repair or replace any OEM parts, textiles, laminate surfaces, and custom products that are found to be defective in material or workmanship within (1) years from the date of original purchase so long as you, the original purchaser, still own it. This is your sole and exclusive remedy. This warranty is subject to the provisions below.

EXCLUSIONS:

1. This warranty does not apply and no other warranty applies to:

- Normal wear and tear.
- Abuse, misuse or accident.
- Modifications or attachments to the product that are not approved by Custom Crafters.
- Products that were not installed, used or maintained in accordance with Custom Crafters instructions and guidelines.
- Products used for rental purposes.

2. Color variations, fabrics and finishes as described below:

- Normal variations in finishes including color, texture and grain variations cannot be avoided, and therefore are not considered defects. Custom Crafters does not warrant the color-fastness or matching of colors, grains or textures of such materials.
- Customer's Own Materials (COM's), Customer's Own Laminates (COL's), textiles and other materials provided by the purchaser.

3. Freight and installation for replacement product will be owner's responsibility.

To the extent allowed by law, Custom Crafters makes no other warranty, either express or implied, including any warranty of merchantability or fitness for a particular purpose. Custom Crafters will not be liable for any consequential or incidental damages.

TO OBTAIN SERVICE UNDER THIS WARRANTY:

Your Custom Crafters dealer is our mutual partner in supporting your warranty requests. By following the procedures outlined below, you can be assured of the best level of service. Please note: Consent of Custom Crafters must be obtained before any warranty work is performed. To obtain consent, please take the following steps:

1. Contact the Dealer from whom the product was purchased within 30 days of discovery of the defect. Be prepared to affirm that you are the original purchaser of the product and to provide the item number(s) from the product in question.
2. Your dealer will gather all pertinent information regarding the claim, inspect the product and contact a Custom Crafters customer service representative. (Please allow a reasonable amount of time for inspection and review.)

If Custom Crafters affirms that the product in question is eligible under the conditions of the warranty as stated above, the customer service representative or another representative of the company will determine whether to provide replacement parts, authorize repairs or replace the product.

Order Placement

Custom Crafters requires that all orders be in writing. This is to insure that orders are complete; to avoid errors; and to avoid duplication. Please order products by item number in order to avoid any possible errors. Telephone orders will not be processed without written confirmation. Custom Crafters will not be held responsible for errors, omissions and order duplication due to non-compliance with this procedure. Order changes and cancellations must also be requested in writing.

Order Acknowledgment

Orders will be acknowledged by a Custom Crafters customer service representative. Please refer to the acknowledgment copy of the Custom Crafters Sales Order to make sure it agrees with your original purchase order. When corresponding, please refer to the Custom Crafters Sales order number.

C.O.M Orders

All C.O.M. products must be sent prepaid to Custom Crafters. All related costs, which include transport, duties and customs brokerage, are the responsibilities of the customer. Any fees charged to Custom Crafters will be invoiced back to the customer.

The customer is responsible for ordering the correct quantity of materials required for the specific order.

There is a 3-6 week production period following the receipt date and identification of your C.O.M.'s. Call for actual leadtime.

Acceptance of customer's own material by Custom Crafters does not indicate a guarantee for product durability, nor is Custom Crafters to be held responsible for any undesirable result with C.O.M. products.

Prices

All prices listed are suggested retail prices. Orders are accepted subject to prices and taxes prevailing at the time of shipment. Prices and taxes are subject to change without notice. If shipping date requested is more than 90 days from date of order, Custom Crafters shall have the right to use the published list prices at the time of shipment.

Terms (Upon acceptance of our credit department)

Net 30 days from date of invoice. Any product sold shall remain the property of Custom Crafters and shall remain the seller's property until paid for. The buyer agrees to perform all acts which may be necessary to protect and assure retention of title to such products by Custom Crafters until such time as goods have been paid for in full.

Quotations

Quotations are good for a period of 30 days.

Lead time specified in quotation starts when the customer's written purchase order is received by a Custom Crafters representative.

Expedited lead may be requested by the Customer. Expedited lead times will have additional charges applied at the customer's expense. These fees will vary with each expedited order.

Changes

The right is reserved by Custom Crafters to make changes, at any time and without prior notice, to prices, colors, materials, specifications and models offered.

Delivery

The scheduled shipping date is specified on our Sales Order acknowledgment. All pick ups from the docks of Custom Crafters **must** be scheduled a minimum of 24 hours in advance. Product will not be handed over without prior notification. Custom Crafters is not liable for delay or failure to deliver goods due to causes beyond our control.

Shipping Weights and Volumes:

Shipping weights and volumes listed are approximate and may vary due to the constantly improving methods of packaging.

Cancellations of Orders

No return of products will be accepted. A charge of 25% will be applied to all orders placed within 7 days of order, if approved. A charge of 75% will be applied to all orders placed after 7 days.

Storage

In the event the purchaser request postponement of shipment beyond the scheduled shipping date, Custom Crafters may store the goods at the purchasers risk and expense. Such transfer to storage shall be deemed delivery to purchaser for all purposes including invoicing and payment.

Freight Claims

The merchandise is carefully packed and thoroughly inspected before leaving the warehouse. Responsibility for its safe delivery is assumed by the carrier upon acceptance of the shipment. Claims for loss or damage sustained in transit must therefore, be made upon the carrier as follows:

1. Concealed loss or damage

Concealed loss or damage means loss or damage that does not become apparent until the merchandise has been unpacked. The contents may be damaged in transit due to rough handling even though the carton may not show external damage. When damage is discovered upon unpacking, contact a Custom Crafters customer service representative within 48 hours of discovery. When applicable, submission of photographs will be requested. Your Custom Crafters customer service representative will work with you to process the claim as well as replace any product deemed damaged in transit.

Damage does not constitute grounds for a return. Replacement parts are readily available. Custom Crafters reserves the right to attempt correction of the damage while retaining the product in the field.

2. Visible Damage or Shortage

Any external evidence of damage or shortage must be noted on the freight bill or delivery receipt. Failure to adequately describe such external evidence of damage or shortage may result in the carrier refusing to honor a damage claim. If there is obvious shipping damage, you may refuse the product and request that the freight carrier return the damaged product to Custom Crafters. Contact a Custom Crafters customer service representative immediately upon receipt of damaged product or shortage.

When placing orders:

- Specify laminate and edge type for all products.
- Use model number for all standard products.
- If order calls for drawing, send drawings with order. Orders placed without drawings will be put on hold until drawings are received.
- Clarify locks, if applicable.
- Specify manufacturer brand when ordering worksurfaces for panel systems, if applicable.

Keep in mind:

- Quotations are good for a period of 30 days.
- Custom works leadtimes are 4-6 weeks.
- There is a \$75 net charge to any high pressure worksurfaces orders with fewer than 3 tops.
- Freight terms are F.O.B Custom Crafters' warehouse.
- All orders with missing information will be put on hold until all applicable information is received. Leadtime may be extended.
- Warpage of free standing tops and panels may occur without proper supports.

Grommets

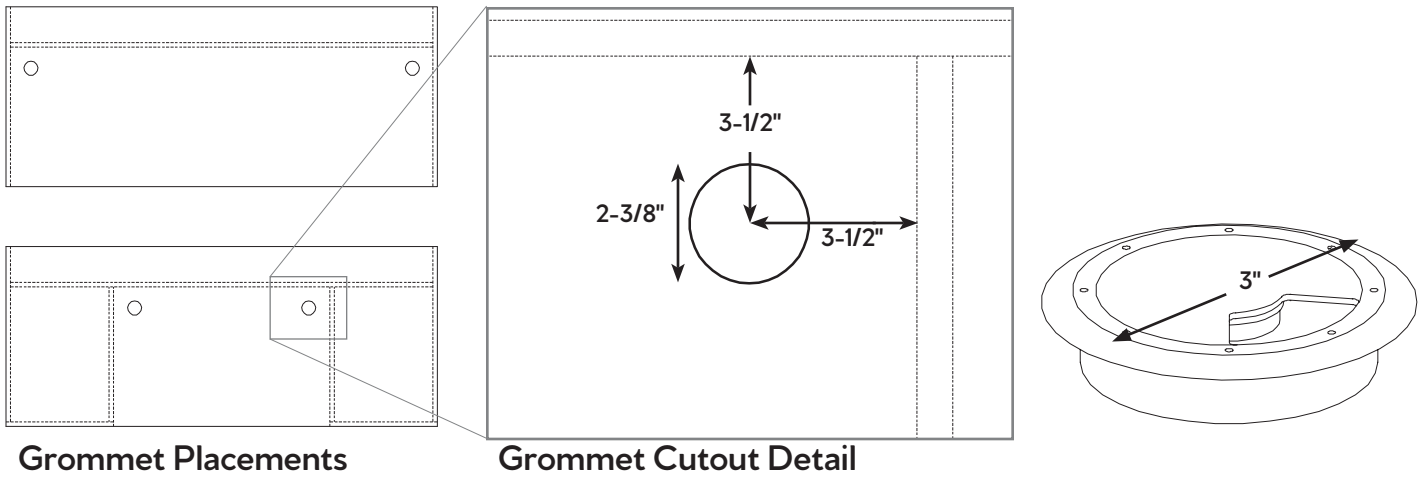

Specifications:

- Grommet Cutouts are 2-1/2" in diameter and are placed 3-1/2" on center away from the inner panel.
- Grommets are \$26 List each.
- For grommet covers, please see page 62.

Scallops

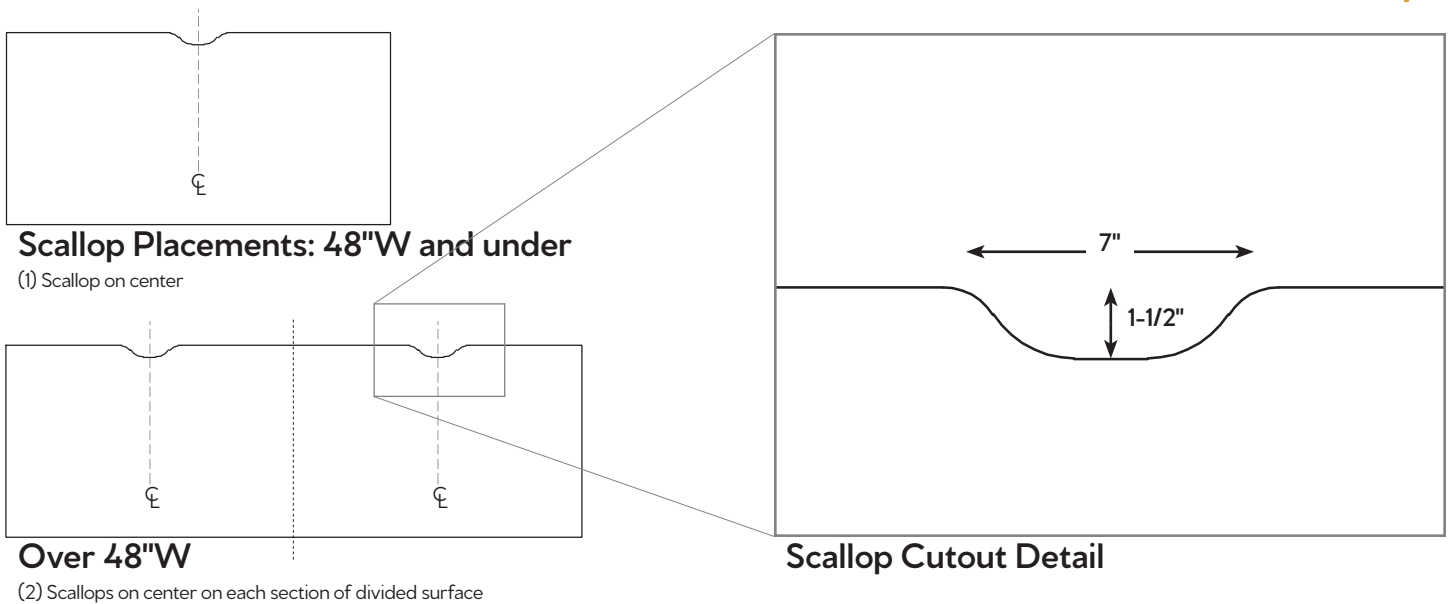

Specifications:

- Scallops are 7" x 1-1/2".
- Scallops are \$40 List each.

Square Corner Rectangle (WSS)

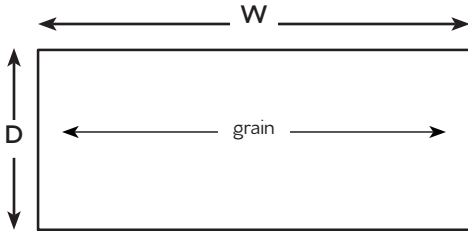

Specifications:

- Square corners
- LP (Thermal Fused Laminate) - 1-1/8" thick.
- HP (High Pressure Laminate) - 1-1/4" thick.
- PolyBak on the underside.
- Edgebanding on all sides.
- Sizes value at 'True Dimensions' unless otherwise specified.
- For a (2) piece top, add \$100 List for spline joint and tight joint fastener.
- Add \$220 List for (2) anti-sag bars.
- Use with Supports on page 34.

How to Order:

- 1) Select Model Number:
WSS2472
- 2) Specify Laminate Type (LP/HP):
WSS2472-LP
- 3) Add Edge Profile: (See page 65)
WSS2472-LP-S2
- 4) Add Laminate/Edge Color: (See page 66)
WSS2472-LP-S2-U204-Black

Note: Additional upcharge will be applied for Premium and HD Premium colors. Please contact Customer Service for pricing and availability.

D		W	Model No.	LP	HP
15	x	24	WSS1524	63	87
15	x	30	WSS1530	75	104
15	x	36	WSS1536	88	121
15	x	42	WSS1542	103	140
15	x	48	WSS1548	115	158
15	x	60	WSS1560	141	194
15	x	72	WSS1572	167	230
15	x	84	WSS1584	194	267
15	x	96	WSS1596	222	305
15	x	108	WSS15108	247	341
15	x	120	WSS15120	272	378
15	x	144	WSS15144	325	448
18	x	18	WSS1818	55	76
18	x	24	WSS1824	71	97
18	x	30	WSS1830	87	116
18	x	36	WSS1836	102	139
18	x	42	WSS1842	125	169
18	x	48	WSS1848	130	180
18	x	60	WSS1860	161	211
18	x	72	WSS1872	189	261
18	x	84	WSS1884	242	336
18	x	96	WSS1896	250	345
18	x	108	WSS18108	278	384
18	x	120	WSS18120	308	427
18	x	144	WSS18144	368	508
24	x	24	WSS2424	85	115
24	x	30	WSS2430	102	139
24	x	36	WSS2436	116	162
24	x	42	WSS2442	149	205
24	x	48	WSS2448	152	211
24	x	60	WSS2460	186	258
24	x	72	WSS2472	222	306
24	x	84	WSS2484	284	380
24	x	96	WSS2496	290	399
24	x	108	WSS24108	355	488
24	x	120	WSS24120	358	497
24	x	144	WSS24144	429	591
30	x	30	WSS3030	136	167
30	x	36	WSS3036	142	196
30	x	42	WSS3042	181	249
30	x	48	WSS3048	182	252
30	x	60	WSS3060	224	311
30	x	72	WSS3072	266	368
30	x	84	WSS3084	343	472
30	x	96	WSS3096	349	482
30	x	108	WSS30108	424	587
30	x	120	WSS30120	432	596
30	x	144	WSS30144	515	710

D		W	Model No.	LP	HP
36	x	36	WSS3636	165	229
36	x	42	WSS3642	212	291
36	x	48	WSS3648	216	296
36	x	60	WSS3660	261	362
36	x	72	WSS3672	312	431
36	x	84	WSS3684	374	554
36	x	96	WSS3696	400	564
36	x	108	WSS36108	499	687
36	x	120	WSS36120	504	697
36	x	144	WSS36144	611	830
42	x	42	WSS4242	272	372
42	x	48	WSS4248	274	379
42	x	60	WSS4260	337	464
42	x	72	WSS4272	396	549
42	x	84	WSS4284	515	712
42	x	96	WSS4296	522	720
42	x	108	WSS42108	640	884
42	x	120	WSS42120	646	893
42	x	144	WSS42144	770	1064
48	x	48	WSS4848	283	382
48	x	60	WSS4860	338	467
48	x	72	WSS4872	400	554
48	x	84	WSS4884	525	718
48	x	96	WSS4896	526	725
48	x	108	WSS48108	644	912
48	x	120	WSS48120	648	899
48	x	144	WSS48144	775	1070
60	x	60	WSS6060	414	574
60	x	72	WSS6072	490	678
60	x	84	WSS6084	636	879
60	x	96	WSS6096	644	888
60	x	108	WSS60108	790	1090
60	x	120	WSS60120	797	1098
60	x	144	WSS60144	949	1311

Square Corner Rectangle (WSS)

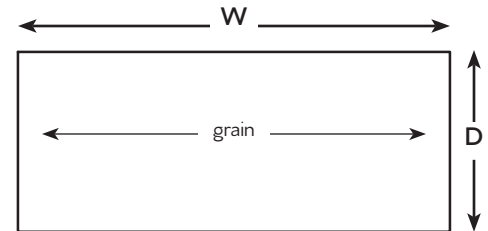

Specifications:

- Square corners
- LP (Thermal Fused Laminate) - 1-1/8" thick.
- HP (High Pressure Laminate) - 1-1/4" thick.
- PolyBak on the underside.
- Edgebanding on all sides.
- Sizes value at 'True Dimensions' unless otherwise specified.
- For a (2) piece top, add \$100 List for spline joint and tight joint fastener.
- Add \$220 List for (2) anti-sag bars.
- Use with Supports on page 34.

How to Order:

- 1) Select Model Number:
WSS2472
- 2) Specify Laminate Type (LP/HP):
WSS2472-LP
- 3) Add Edge Profile: (See page 65)
WSS2472-LP-S2
- 4) Add Laminate/Edge Color: (See page 66)
WSS2472-LP-S2-U204-Black

Note: Additional upcharge will be applied for Premium and HD Premium colors. Please contact Customer Service for pricing and availability.

Prices shown are for standard stock laminate. Refer to page 66 for standard laminate colors. Refer to page 65 for edge profiles and page 67 for standard edgeband colors.

Grommets: \$26 List Scallops: \$40 List
Refer to page 11 for grommet and scallop cutout detail.

Radius Corner Rectangle (WSR)

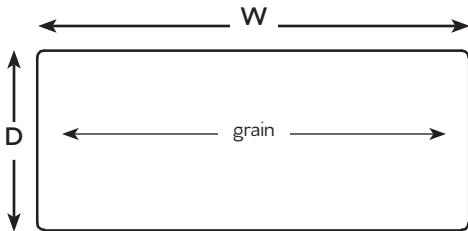

Specifications:

- Rounded corners
- LP (Thermal Fused Laminate) - 1-1/8" thick.
- HP (High Pressure Laminate) - 1-1/4" thick.
- PolyBak on the underside.
- Edgebanding on all sides.
- Sizes value at 'True Dimensions' unless otherwise specified.
- For a (2) piece top, add \$100 List for spline joint and tight joint fastener.
- Add \$220 List for (2) anti-sag bars.
- Use with Supports on page 34.

How to Order:

- 1) Select Model Number:
WSS2472
- 2) Specify Laminate Type (LP/HP):
WSS2472-LP
- 3) Add Edge Profile: (See page 65)
WSS2472-LP-S2
- 4) Add Laminate/Edge Color: (See page 66)
WSS2472-LP-S2-U204-Black

Note: Additional upcharge will be applied for Premium and HD Premium colors. Please contact Customer Service for pricing and availability.

D	W	Model No.	LP	HP	
18	x	18	WSR1818	81	113
18	x	24	WSR1824	103	140
18	x	30	WSR1830	120	186
18	x	36	WSR1836	141	193
18	x	42	WSR1842	125	169
18	x	48	WSR1848	179	247
18	x	60	WSR1860	217	300
18	x	72	WSR1872	257	354
18	x	84	WSR1884	316	436
18	x	96	WSR1896	332	458
18	x	108	WSR18108	393	543
18	x	120	WSR18120	410	565
18	x	144	WSR18144	488	671
24	x	24	WSR2424	119	164
24	x	30	WSR2430	141	193
24	x	36	WSR2436	163	223
24	x	42	WSR2442	197	272
24	x	48	WSR2448	204	283
24	x	60	WSR2460	248	343
24	x	72	WSR2472	290	400
24	x	84	WSR2484	362	501
24	x	96	WSR2496	378	520
24	x	108	WSR24108	448	618
24	x	120	WSR24120	464	640
24	x	144	WSR24144	549	758
30	x	30	WSR3030	164	227
30	x	36	WSR3036	190	261
30	x	42	WSR3042	234	321
30	x	48	WSR3048	239	332
30	x	60	WSR3060	290	399
30	x	72	WSR3072	339	470
30	x	84	WSR3084	424	587
30	x	96	WSR3096	437	609
30	x	108	WSR30108	525	724
30	x	120	WSR30120	541	746
30	x	144	WSR30144	640	884

D	W	Model No.	LP	HP
36	x	36	WSR3636	218 302
36	x	42	WSR3642	245 369
36	x	48	WSR3648	275 381
36	x	60	WSR3660	332 458
36	x	72	WSR3672	391 538
36	x	84	WSR3684	489 674
36	x	96	WSR3696	503 700
36	x	108	WSR36108	602 832
36	x	120	WSR36120	618 852
36	x	144	WSR36144	732 1010
42	x	42	WSR4242	330 457
42	x	48	WSR4248	338 467
42	x	60	WSR4260	410 565
42	x	72	WSR4272	480 664
42	x	84	WSR4284	608 839
42	x	96	WSR4296	623 860
42	x	108	WSR42108	750 1031
42	x	120	WSR42120	765 1058
42	x	144	WSR42144	905 1118
48	x	48	WSR4848	346 477
48	x	60	WSR4860	417 577
48	x	72	WSR4872	489 612
48	x	84	WSR4884	615 850
48	x	96	WSR4896	630 870
48	x	108	WSR48108	756 1044
48	x	120	WSR48120	842 1065
48	x	144	WSR48144	914 1262
60	x	60	WSR6060	503 696
60	x	72	WSR6072	587 810
60	x	84	WSR6084	741 1023
60	x	96	WSR6096	756 1044
60	x	108	WSR60108	911 1258
60	x	120	WSR60120	928 1279
60	x	144	WSR60144	1096 1513

Radius Corner Rectangle (WSR)

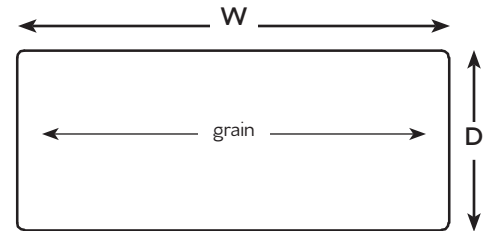

Specifications:

- Rounded corners
- LP (Thermal Fused Laminate) - 1-1/8" thick.
- HP (High Pressure Laminate) - 1-1/4" thick.
- PolyBak on the underside.
- Edgebanding on all sides.
- Sizes value at 'True Dimensions' unless otherwise specified.
- For a (2) piece top, add \$100 List for spline joint and tight joint fastener.
- Add \$220 List for (2) anti-sag bars.
- Use with Supports on page 34.

How to Order:

- 1) Select Model Number:
WSS2472
- 2) Specify Laminate Type (LP/HP):
WSS2472-LP
- 3) Add Edge Profile: (See page 65)
WSS2472-LP-S2
- 4) Add Laminate/Edge Color: (See page 66)
WSS2472-LP-S2-U204-Black

Note: Additional upcharge will be applied for Premium and HD Premium colors. Please contact Customer Service for pricing and availability.

Prices shown are for standard stock laminate. Refer to page 66 for standard laminate colors. Refer to page 65 for edge profiles and page 67 for standard edgeband colors.

Grommets: \$26 List Scallops: \$40 List
Refer to page 11 for grommet and scallop cutout detail.

Extended Corner Left (ECSL)

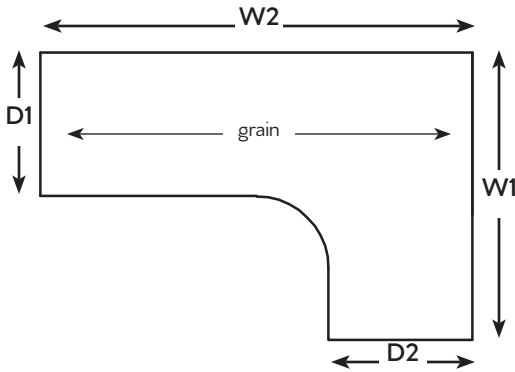

Specifications:

- LP (Thermal Fused Laminate) - 1-1/8" thick.
- HP (High Pressure Laminate) - 1-1/4" thick.
- PolyBak on the underside.
- Edgebanding on all edges.
- Sizes value at 'True Dimensions' unless otherwise specified.
- For a (2) piece top, add \$100 List for spline joint and tight joint fastener.
- Add \$220 List for (2) anti-sag bars.
- Use with Supports on page 34.

How to Order:

- 1) Select Model Number:
WSS2472
- 2) Specify Laminate Type (LP/HP):
WSS2472-LP
- 3) Add Edge Profile: (See page 65)
WSS2472-LP-S2
- 4) Add Laminate/Edge Color: (See page 66)
WSS2472-LP-S2-U204-Black

Note: Additional upcharge will be applied for Premium and HD Premium colors. Please contact Customer Service for pricing and availability.

W1	W2	D1	D2	Model No.	LP	HP
36	60	24	24	ECSL36602424	267	369
36	60	24	30	ECSL36602430	267	369
36	60	30	24	ECSL36603024	267	369
36	60	30	30	ECSL36603030	267	369
36	72	24	24	ECSL36722424	317	436
36	72	24	30	ECSL36722430	317	436
36	72	30	24	ECSL36723024	317	436
36	72	30	30	ECSL36723030	317	436
36	84	24	24	ECSL36842424	367	505
36	84	24	30	ECSL36842430	367	505
36	84	30	24	ECSL36843024	367	505
36	84	30	30	ECSL36843030	367	505
36	96	24	24	ECSL36962424	414	574
36	96	24	30	ECSL36962430	414	574
36	96	30	24	ECSL36963024	414	574
36	96	30	30	ECSL36963030	414	574
42	60	24	24	ECSL42602424	297	415
42	60	24	30	ECSL42602430	297	415
42	60	30	24	ECSL42603024	297	415
42	60	30	30	ECSL42603030	297	415
42	72	24	24	ECSL42722424	354	487
42	72	24	30	ECSL42722430	354	487
42	72	30	24	ECSL42723024	354	487
42	72	30	30	ECSL42723030	354	487
42	84	24	24	ECSL42842424	407	563
42	84	24	30	ECSL42842430	407	563
42	84	30	24	ECSL42843024	407	563
42	84	30	30	ECSL42843030	407	563
42	96	24	24	ECSL42962424	462	636
42	96	24	30	ECSL42962430	462	636
42	96	30	24	ECSL42963024	462	636
42	96	30	30	ECSL42963030	462	636

Extended Corner Left (ECSL)

W1	W2	D1	D2	Model No.	LP	HP
48	60	24	24	ECSL48602424	336	462
48	60	24	30	ECSL48602430	336	462
48	60	30	24	ECSL48603024	336	462
48	60	30	30	ECSL48603030	336	462
48	72	24	24	ECSL48722424	392	547
48	72	24	30	ECSL48722430	392	547
48	72	30	24	ECSL48723024	392	547
48	72	30	30	ECSL48723030	392	547
48	84	24	24	ECSL48842424	458	633
48	84	24	30	ECSL48842430	458	633
48	84	30	24	ECSL48843024	458	633
48	84	30	30	ECSL48843030	458	633
48	96	24	24	ECSL48962424	520	681
48	96	24	30	ECSL48962430	520	681
48	96	30	24	ECSL48963024	520	681
48	96	30	30	ECSL48963030	520	681
60	60	24	24	ECSL60602424	411	566
60	60	24	30	ECSL60602430	411	566
60	60	30	24	ECSL60603024	411	566
60	60	30	30	ECSL60603030	411	566
60	72	24	24	ECSL60722424	488	672
60	72	24	30	ECSL60722430	488	672
60	72	30	24	ECSL60723024	488	672
60	72	30	30	ECSL60723030	488	672
60	84	24	24	ECSL60842424	563	776
60	84	24	30	ECSL60842430	563	776
60	84	30	24	ECSL60843024	563	776
60	84	30	30	ECSL60843030	563	776
60	96	24	24	ECSL60962424	636	879
60	96	24	30	ECSL60962430	636	879
60	96	30	24	ECSL60963024	636	879
60	96	30	30	ECSL60963030	636	879

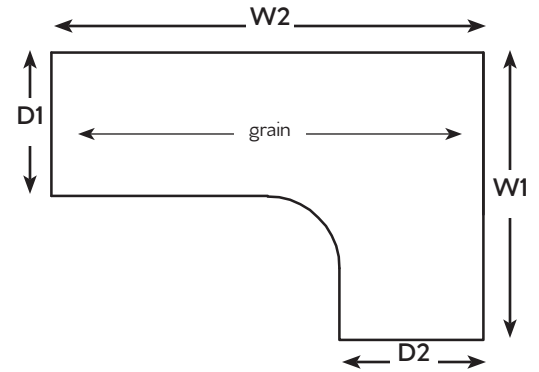

Specifications:

- LP (Thermal Fused Laminate) - 1-1/8" thick.
- HP (High Pressure Laminate) - 1-1/4" thick.
- PolyBak on the underside.
- Edgebanding on all edges.
- Sizes value at 'True Dimensions' unless otherwise specified.
- For a (2) piece top, add \$100 List for spline joint and tight joint fastener.
- Add \$220 List for (2) anti-sag bars.
- Use with Supports on page 34.

How to Order:

- 1) Select Model Number:
[WSS2472](#)
- 2) Specify Laminate Type (LP/HP):
[WSS2472-LP](#)
- 3) Add Edge Profile: (See page 65)
[WSS2472-LP-S2](#)
- 4) Add Laminate/Edge Color: (See page 66)
[WSS2472-LP-S2-U204-Black](#)

Note: Additional upcharge will be applied for Premium and HD Premium colors. Please contact Customer Service for pricing and availability.

Prices shown are for standard stock laminate. Refer to page 66 for standard laminate colors. Refer to page 65 for edge profiles and page 67 for standard edgeband colors.

Grommets: \$26 List Scallops: \$40 List
Refer to page 11 for grommet and scallop cutout detail.

Extended Corner Right (ECSR)

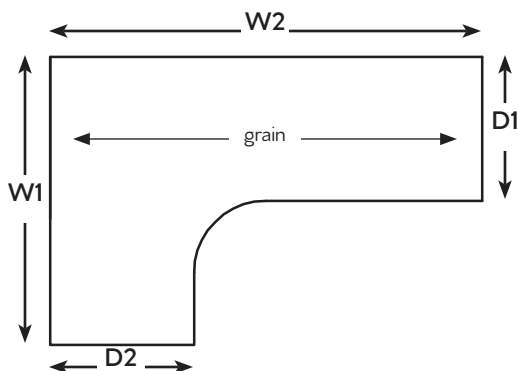

Specifications:

- LP (Thermal Fused Laminate) - 1-1/8" thick.
- HP (High Pressure Laminate) - 1-1/4" thick.
- PolyBak on the underside.
- Edgebanding on all edges.
- Sizes value at 'True Dimensions' unless otherwise specified.
- For a (2) piece top, add \$100 List for spline joint and tight joint fastener.
- Add \$220 List for (2) anti-sag bars.
- Use with Supports on page 34.

How to Order:

- 1) Select Model Number:
WSS2472
- 2) Specify Laminate Type (LP/HP):
WSS2472-LP
- 3) Add Edge Profile: (See page 65)
WSS2472-LP-S2
- 4) Add Laminate/Edge Color: (See page 66)
WSS2472-LP-S2-U204-Black

Note: Additional upcharge will be applied for Premium and HD Premium colors. Please contact Customer Service for pricing and availability.

W1	W2	D1	D2	Model No.	LP	HP
36	60	24	24	ECSR36602424	163	369
36	60	24	30	ECSR36602430	163	369
36	60	30	24	ECSR36603024	163	369
36	60	30	30	ECSR36603030	163	369
36	72	24	24	ECSR36722424	317	436
36	72	24	30	ECSR36722430	317	436
36	72	30	24	ECSR36723024	317	436
36	72	30	30	ECSR36723030	317	436
36	84	24	24	ECSR36842424	367	494
36	84	24	30	ECSR36842430	367	494
36	84	30	24	ECSR36843024	367	494
36	84	30	30	ECSR36843030	367	494
36	96	24	24	ECSR36962424	414	574
36	96	24	30	ECSR36962430	414	574
36	96	30	24	ECSR36963024	414	574
36	96	30	30	ECSR36963030	414	574
42	60	24	24	ECSR42602424	297	410
42	60	24	30	ECSR42602430	297	410
42	60	30	24	ECSR42603024	297	410
42	60	30	30	ECSR42603030	297	410
42	72	24	24	ECSR42722424	354	487
42	72	24	30	ECSR42722430	354	487
42	72	30	24	ECSR42723024	354	487
42	72	30	30	ECSR42723030	354	487
42	84	24	24	ECSR42842424	407	563
42	84	24	30	ECSR42842430	407	563
42	84	30	24	ECSR42843024	407	563
42	84	30	30	ECSR42843030	407	563
42	96	24	24	ECSR42962424	462	636
42	96	24	30	ECSR42962430	462	636
42	96	30	24	ECSR42963024	462	636
42	96	30	30	ECSR42963030	462	636

W1	W2	D1	D2	Model No.	LP	HP
48	60	24	24	ECSR48602424	336	462
48	60	24	30	ECSR48602430	336	462
48	60	30	24	ECSR48603024	336	462
48	60	30	30	ECSR48603030	336	462
48	72	24	24	ECSR48722424	395	547
48	72	24	30	ECSR48722430	395	547
48	72	30	24	ECSR48723024	395	547
48	72	30	30	ECSR48723030	395	547
48	84	24	24	ECSR48842424	458	633
48	84	24	30	ECSR48842430	458	633
48	84	30	24	ECSR48843024	458	633
48	84	30	30	ECSR48843030	458	633
48	96	24	24	ECSR48962424	482	659
48	96	24	30	ECSR48962430	482	659
48	96	30	24	ECSR48963024	482	659
48	96	30	30	ECSR48963030	482	659
60	60	24	24	ECSR60602424	411	566
60	60	24	30	ECSR60602430	411	566
60	60	30	24	ECSR60603024	411	566
60	60	30	30	ECSR60603030	411	566
60	72	24	24	ECSR60722424	488	671
60	72	24	30	ECSR60722430	488	671
60	72	30	24	ECSR60723024	488	671
60	72	30	30	ECSR60723030	488	671
60	84	24	24	ECSR60842424	563	776
60	84	24	30	ECSR60842430	563	776
60	84	30	24	ECSR60843024	563	776
60	84	30	30	ECSR60843030	563	776
60	96	24	24	ECSR60962424	636	879
60	96	24	30	ECSR60962430	636	879
60	96	30	24	ECSR60963024	636	879
60	96	30	30	ECSR60963030	636	879

Extended Corner Right (ECSR)

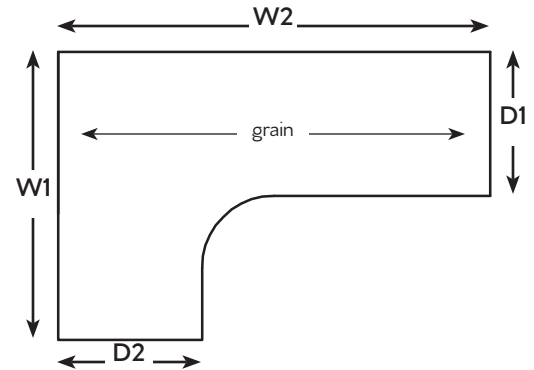

Specifications:

- LP (Thermal Fused Laminate) - 1-1/8" thick.
- HP (High Pressure Laminate) - 1-1/4" thick.
- PolyBak on the underside.
- Edgebanding on all edges.
- Sizes value at 'True Dimensions' unless otherwise specified.
- For a (2) piece top, add \$100 List for spline joint and tight joint fastener.
- Add \$220 List for (2) anti-sag bars.
- Use with Supports on page 34.

How to Order:

- 1) Select Model Number:
[WSS2472](#)
- 2) Specify Laminate Type (LP/HP):
[WSS2472-LP](#)
- 3) Add Edge Profile: (See page 65)
[WSS2472-LP-S2](#)
- 4) Add Laminate/Edge Color: (See page 66)
[WSS2472-LP-S2-U204-Black](#)

Note: Additional upcharge will be applied for Premium and HD Premium colors. Please contact Customer Service for pricing and availability.

Prices shown are for standard stock laminate. Refer to page 66 for standard laminate colors. Refer to page 65 for edge profiles and page 67 for standard edgeband colors.

Grommets: \$26 List Scallops: \$40 List
Refer to page 11 for grommet and scallop cutout detail.

Extended Corner Left with Radius (ECRL)

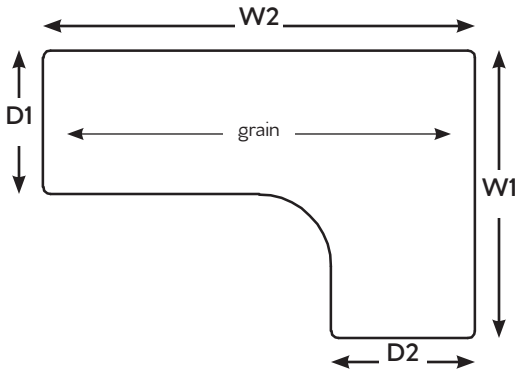

Specifications:

- LP (Thermal Fused Laminate) - 1-1/8" thick.
- HP (High Pressure Laminate) - 1-1/4" thick.
- PolyBak on the underside.
- Edgebanding on all edges.
- Sizes value at 'True Dimensions' unless otherwise specified.
- For a (2) piece top, add \$100 List for spline joint and tight joint fastner.
- Add \$220 List for (2) anti-sag bars.
- Use with Supports on page 34.

How to Order:

- 1) Select Model Number:
WSS2472
- 2) Specify Laminate Type (LP/HP):
WSS2472-LP
- 3) Add Edge Profile: (See page 65)
WSS2472-LP-S2
- 4) Add Laminate/Edge Color: (See page 66)
WSS2472-LP-S2-U204-Black

Note: Additional upcharge will be applied for Premium and HD Premium colors. Please contact Customer Service for pricing and availability.

W1	W2	D1	D2	Model No.	LP	HP
36	60	24	24	ECRL36602424	336	462
36	60	24	30	ECRL36602430	336	462
36	60	30	24	ECRL36603024	336	462
36	60	30	30	ECRL36603030	336	462
36	72	24	24	ECRL36722424	395	545
36	72	24	30	ECRL36722430	395	545
36	72	30	24	ECRL36723024	395	545
36	72	30	30	ECRL36723030	395	545
36	84	24	24	ECRL36842424	457	633
36	84	24	30	ECRL36842430	457	633
36	84	30	24	ECRL36843024	457	633
36	84	30	30	ECRL36843030	457	633
36	96	24	24	ECRL36962424	517	718
36	96	24	30	ECRL36962430	517	718
36	96	30	24	ECRL36963024	517	718
36	96	30	30	ECRL36963030	517	718
42	60	24	24	ECRL42602424	371	513
42	60	24	30	ECRL42602430	371	513
42	60	30	24	ECRL42603024	371	513
42	60	30	30	ECRL42603030	371	513
42	72	24	24	ECRL42722424	439	608
42	72	24	30	ECRL42722430	439	608
42	72	30	24	ECRL42723024	439	608
42	72	30	30	ECRL42723030	439	608
42	84	24	24	ECRL42842424	507	701
42	84	24	30	ECRL42842430	507	701
42	84	30	24	ECRL42843024	507	701
42	84	30	30	ECRL42843030	507	701
42	96	24	24	ECRL42962424	577	796
42	96	24	30	ECRL42962430	577	796
42	96	30	24	ECRL42963024	577	796
42	96	30	30	ECRL42963030	577	796

W1	W2	D1	D2	Model No.	LP	HP
48	60	24	24	ECRL48602424	416	578
48	60	24	30	ECRL48602430	416	578
48	60	30	24	ECRL48603024	416	578
48	60	30	30	ECRL48603030	416	578
48	72	24	24	ECRL48722424	493	685
48	72	24	30	ECRL48722430	493	685
48	72	30	24	ECRL48723024	493	685
48	72	30	30	ECRL48723030	493	685
48	84	24	24	ECRL48842424	572	790
48	84	24	30	ECRL48842430	572	790
48	84	30	24	ECRL48843024	572	790
48	84	30	30	ECRL48843030	572	790
48	96	24	24	ECRL48962424	649	898
48	96	24	30	ECRL48962430	649	898
48	96	30	24	ECRL48963024	649	898
48	96	30	30	ECRL48963030	649	898
60	60	24	24	ECRL60602424	512	706
60	60	24	30	ECRL60602430	512	706
60	60	30	24	ECRL60603024	512	706
60	60	30	30	ECRL60603030	512	706
60	72	24	24	ECRL60722424	608	839
60	72	24	30	ECRL60722430	608	839
60	72	30	24	ECRL60723024	608	839
60	72	30	30	ECRL60723030	608	839
60	84	24	24	ECRL60842424	701	968
60	84	24	30	ECRL60842430	701	968
60	84	30	24	ECRL60843024	701	968
60	84	30	30	ECRL60843030	701	968
60	96	24	24	ECRL60962424	795	1099
60	96	24	30	ECRL60962430	795	1099
60	96	30	24	ECRL60963024	795	1099
60	96	30	30	ECRL60963030	795	1099

Extended Corner Left with Radius (ECRL)

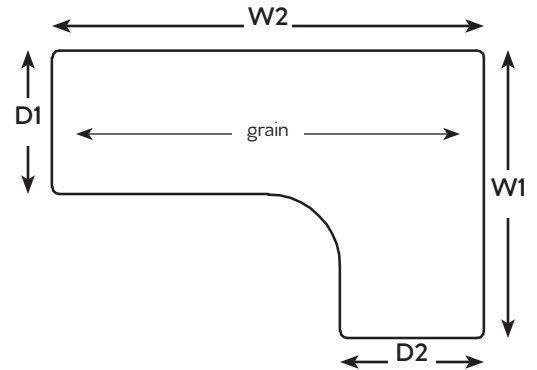

Specifications:

- LP (Thermal Fused Laminate) - 1-1/8" thick.
- HP (High Pressure Laminate) - 1-1/4" thick.
- PolyBak on the underside.
- Edgebanding on all edges.
- Sizes value at 'True Dimensions' unless otherwise specified.
- For a (2) piece top, add \$100 List for spline joint and tight joint fastener.
- Add \$220 List for (2) anti-sag bars.
- Use with Supports on page 34.

How to Order:

- 1) Select Model Number:
WSS2472
- 2) Specify Laminate Type (LP/HP):
WSS2472-LP
- 3) Add Edge Profile: (See page 65)
WSS2472-LP-S2
- 4) Add Laminate/Edge Color: (See page 66)
WSS2472-LP-S2-U204-Black

Note: Additional upcharge will be applied for Premium and HD Premium colors. Please contact Customer Service for pricing and availability.

Prices shown are for standard stock laminate. Refer to page 66 for standard laminate colors. Refer to page 65 for edge profiles and page 67 for standard edgeband colors.
Grommets: \$26 List Scallops: \$40 List
Refer to page 11 for grommet and scallop cutout detail.

Extended Corner Right with Radius (ECRR)

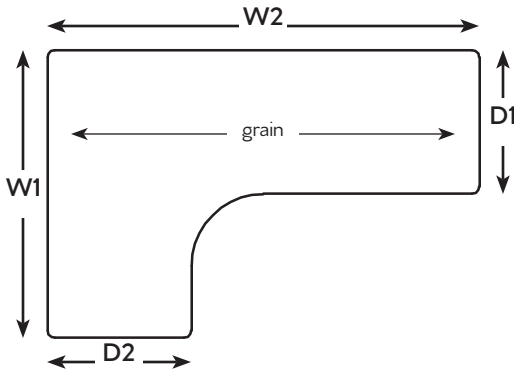

Specifications:

- LP (Thermal Fused Laminate) - 1-1/8" thick.
- HP (High Pressure Laminate) - 1-1/4" thick.
- PolyBak on the underside.
- Edgebanding on all edges.
- Sizes value at 'True Dimensions' unless otherwise specified.
- For a (2) piece top, add \$100 List for spline joint and tight joint fastener.
- Add \$220 List for (2) anti-sag bars.
- Use with Supports on page 34.

How to Order:

- 1) Select Model Number:
WSS2472
- 2) Specify Laminate Type (LP/HP):
WSS2472-LP
- 3) Add Edge Profile: (See page 65)
WSS2472-LP-S2
- 4) Add Laminate/Edge Color: (See page 66)
WSS2472-LP-S2-U204-Black

Note: Additional upcharge will be applied for Premium and HD Premium colors. Please contact Customer Service for pricing and availability.

W1	W2	D1	D2	Model No.	LP	HP
36	60	24	24	ECRR36602424	336	461
36	60	24	30	ECRR36602430	336	461
36	60	30	24	ECRR36603024	336	461
36	60	30	30	ECRR36603030	336	461
36	72	24	24	ECRR36722424	395	545
36	72	24	30	ECRR36722430	395	545
36	72	30	24	ECRR36723024	395	545
36	72	30	30	ECRR36723030	395	545
36	84	24	24	ECRR36842424	457	632
36	84	24	30	ECRR36842430	457	632
36	84	30	24	ECRR36843024	457	632
36	84	30	30	ECRR36843030	457	632
36	96	24	24	ECRR36962424	517	717
36	96	24	30	ECRR36962430	517	717
36	96	30	24	ECRR36963024	517	717
36	96	30	30	ECRR36963030	517	717
42	60	24	24	ECRR42602424	371	512
42	60	24	30	ECRR42602430	371	512
42	60	30	24	ECRR42603024	371	512
42	60	30	30	ECRR42603030	371	512
42	72	24	24	ECRR42722424	438	607
42	72	24	30	ECRR42722430	438	607
42	72	30	24	ECRR42723024	438	607
42	72	30	30	ECRR42723030	438	607
42	84	24	24	ECRR42842424	506	701
42	84	24	30	ECRR42842430	506	701
42	84	30	24	ECRR42843024	506	701
42	84	30	30	ECRR42843030	506	701
42	96	24	24	ECRR42962424	577	796
42	96	24	30	ECRR42962430	577	796
42	96	30	24	ECRR42963024	577	796
42	96	30	30	ECRR42963030	577	796

W1	W2	D1	D2	Model No.	LP	HP
48	60	24	24	ECRR48602424	416	578
48	60	24	30	ECRR48602430	416	578
48	60	30	24	ECRR48603024	416	578
48	60	30	30	ECRR48603030	416	578
48	72	24	24	ECRR48722424	493	685
48	72	24	30	ECRR48722430	493	685
48	72	30	24	ECRR48723024	493	685
48	72	30	30	ECRR48723030	493	685
48	84	24	24	ECRR48842424	572	790
48	84	24	30	ECRR48842430	572	790
48	84	30	24	ECRR48843024	572	790
48	84	30	30	ECRR48843030	572	790
48	96	24	24	ECRR48962424	649	898
48	96	24	30	ECRR48962430	649	898
48	96	30	24	ECRR48963024	649	898
48	96	30	30	ECRR48963030	649	898
60	60	24	24	ECRR60602424	512	706
60	60	24	30	ECRR60602430	512	706
60	60	30	24	ECRR60603024	512	706
60	60	30	30	ECRR60603030	512	706
60	72	24	24	ECRR60722424	608	839
60	72	24	30	ECRR60722430	608	839
60	72	30	24	ECRR60723024	608	839
60	72	30	30	ECRR60723030	608	839
60	84	24	24	ECRR60842424	701	968
60	84	24	30	ECRR60842430	701	968
60	84	30	24	ECRR60843024	701	968
60	84	30	30	ECRR60843030	701	968
60	96	24	24	ECRR60962424	795	1099
60	96	24	30	ECRR60962430	795	1099
60	96	30	24	ECRR60963024	795	1099
60	96	30	30	ECRR60963030	795	1099

Extended Corner Right with Radius (ECRR)

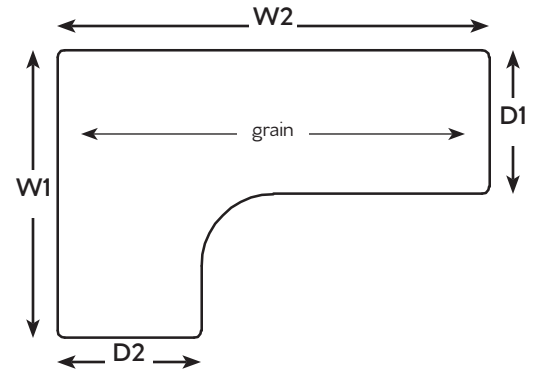

Specifications:

- LP (Thermal Fused Laminate) - 1-1/8" thick.
- HP (High Pressure Laminate) - 1-1/4" thick.
- PolyBak on the underside.
- Edgebanding on all edges.
- Sizes value at 'True Dimensions' unless otherwise specified.
- For a (2) piece top, add \$100 List for spline joint and tight joint fastener.
- Add \$220 List for (2) anti-sag bars.
- Use with Supports on page 34.

How to Order:

- 1) Select Model Number:
WSS2472
- 2) Specify Laminate Type (LP/HP):
WSS2472-LP
- 3) Add Edge Profile: (See page 65)
WSS2472-LP-S2
- 4) Add Laminate/Edge Color: (See page 66)
WSS2472-LP-S2-U204-Black

Note: Additional upcharge will be applied for Premium and HD Premium colors. Please contact Customer Service for pricing and availability.

Prices shown are for standard stock laminate. Refer to page 66 for standard laminate colors. Refer to page 65 for edge profiles and page 67 for standard edgeband colors.

Grommets: \$26 List Scallops: \$40 List
Refer to page 11 for grommet and scallop cutout detail.

Straight Corner (SCS)

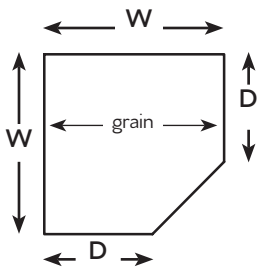

D	W	Model No.	LP	HP
24	36	SCS2436	164	225
24	42	SCS2442	239	329
24	48	SCS2448	273	376
30	42	SCS3042	239	329
30	48	SCS3048	273	376

Straight Corner with Radius (SCR)

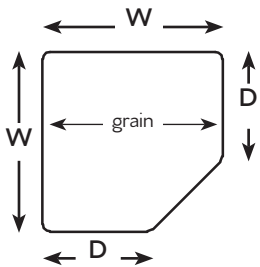

D	W	Model No.	LP	HP
24	36	SCR2436	203	280
24	42	SCR2442	300	412
24	48	SCR2448	340	471
30	42	SCR3042	300	412
30	48	SCR3048	340	471

Curved Corner (CCS)

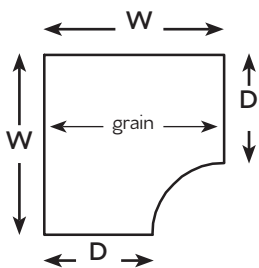

D	W	Model No.	LP	HP
24	36	CCS2436	196	270
24	42	CCS2442	278	383
24	48	CCS2448	316	471
30	42	CCS3042	278	383
30	48	CCS3048	316	436

Curved Corner with Radius (CCR)

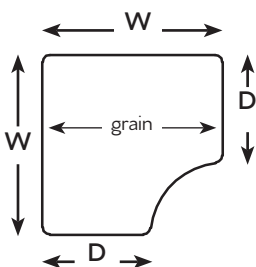

D	W	Model No.	LP	HP
24	36	CCR2436	246	338
24	42	CCR2442	347	479
24	48	CCR2448	395	545
30	42	CCR3042	347	479
30	48	CCR3048	366	545

D		W	Model No.	LP	HP
18	x	18	QRS18	75	105
24	x	24	QRS24	106	145
30	x	30	QRS30	146	204
36	x	36	QRS36	199	274
42	x	42	QRS42	306	424
48	x	48	QRS48	318	436
60	x	60	QRS60	469	647

D		W	Model No.	LP	HP
18	x	18	QRR18	94	130
24	x	24	QRR24	131	181
30	x	30	QRR30	184	253
36	x	36	QRR36	249	343
42	x	42	QRR42	383	530
48	x	48	QRR48	400	552
60	x	60	QRR60	582	809

Quarter Round (QRS)

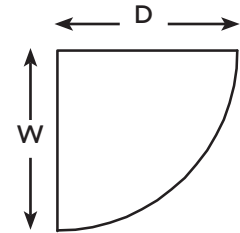

Quarter Round with Radius (QRR)

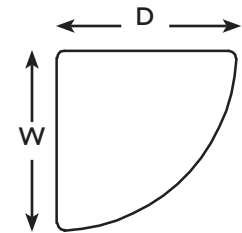

Specifications:

- LP (Thermal Fused Laminate) - 1-1/8" thick.
- HP (High Pressure Laminate) - 1-1/4" thick.
- Edgebanding on all edges.
- Sizes value at 'True Dimensions' unless otherwise specified.
- Use with Supports on page 34.

How to Order:

- 1) Select Model Number:
WSS2472
- 2) Specify Laminate Type (LP/HP):
WSS2472-LP
- 3) Add Edge Profile: (See page 65)
WSS2472-LP-S2
- 4) Add Laminate/Edge Color: (See page 66)
WSS2472-LP-S2-U204-Black

Note: Additional upcharge will be applied for Premium and HD Premium colors. Please contact Customer Service for pricing and availability.

Prices shown are for standard stock laminate. Refer to page 66 for standard laminate colors. Refer to page 65 for edge profiles and page 67 for standard edgeband colors.

Grommets: \$26 List Scallops: \$40 List
Refer to page 11 for grommet and scallop cutout detail.

Half-Round (HRS)

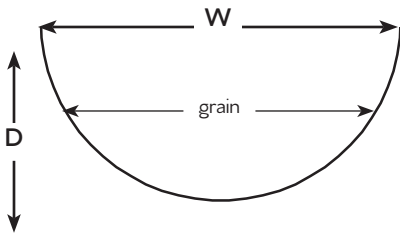

D		W	Model No.	LP	HP
12	x	24	HRS24	74	104
15	x	30	HRS30	113	141
18	x	36	HRS36	141	193
21	x	42	HRS42	194	160
24	x	48	HRS48	204	282
30	x	60	HRS60	290	399

Half-Round with Radius (HRR)

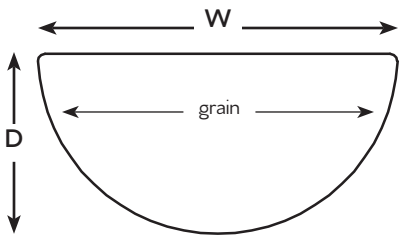

D		W	Model No.	LP	HP
12	x	24	HRR24	93	129
15	x	30	HRR30	128	178
18	x	36	HRR36	176	240
21	x	42	HRR42	240	330
24	x	48	HRR48	256	353
30	x	60	HRR60	362	500

Specifications:

- LP (Thermal Fused Laminate) - 1-1/8" thick.
- HP (High Pressure Laminate) - 1-1/4" thick.
- Edgebanding on all edges.
- Sizes value at 'True Dimensions' unless otherwise specified.
- Use with Supports on page 34.

How to Order:

- 1) Select Model Number:
WSS2472
- 2) Specify Laminate Type (LP/HP):
WSS2472-LP
- 3) Add Edge Profile: (See page 65)
WSS2472-LP-S2
- 4) Add Laminate/Edge Color: (See page 66)
WSS2472-LP-S2-U204-Black

Note: Additional upcharge will be applied for Premium and HD Premium colors. Please contact Customer Service for pricing and availability.

Transition Top (TTSL/TTSR)

D1	D2	W	Model No.	LP	HP
24	30	36	TTSL243036	150	208
24	30	42	TTSL243042	192	261
24	30	48	TTSL243048	194	281
24	30	60	TTSL243060	237	326
24	30	72	TTSL243072	278	384
24	30	36	TTSR243036	150	208
24	30	42	TTSR243042	190	261
24	30	48	TTSR243048	194	281
24	30	60	TTSR243060	237	326
24	30	72	TTSR243072	278	384

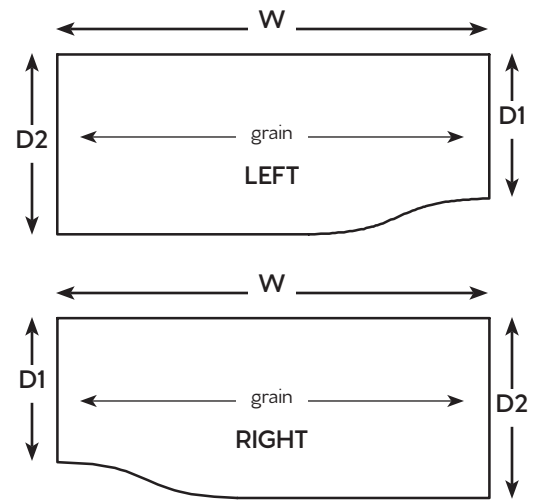

Transition Top with Radius (TTRL/TTRR)

D1	D2	W	Model No.	LP	HP
24	30	36	TTRL243036	186	259
24	30	42	TTRL243042	237	326
24	30	48	TTRL243048	240	336
24	30	60	TTRL243060	294	409
24	30	72	TTRL243072	349	482
24	30	36	TTRR243036	186	259
24	30	42	TTRR243042	237	326
24	30	48	TTRR243048	240	336
24	30	60	TTRR243060	294	409
24	30	72	TTRR243072	349	482

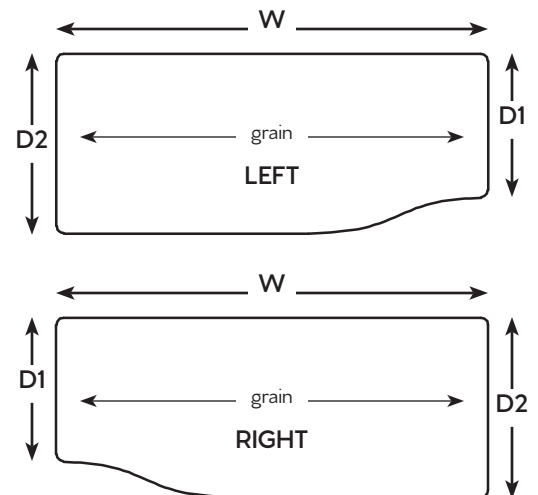

Specifications:

- LP (Thermal Fused Laminate) - 1-1/8" thick.
- HP (High Pressure Laminate) - 1-1/4" thick.
- Edgebanding on all edges.
- Sizes value at 'True Dimensions' unless otherwise specified.
- Use with Supports on page 34.

How to Order:

- 1) Select Model Number:
WSS2472
- 2) Specify Laminate Type (LP/HP):
WSS2472-LP
- 3) Add Edge Profile: (See page 65)
WSS2472-LP-S2
- 4) Add Laminate/Edge Color: (See page 66)
WSS2472-LP-S2-U204-Black

Note: Additional upcharge will be applied for Premium and HD Premium colors. Please contact Customer Service for pricing and availability.

Prices shown are for standard stock laminate. Refer to page 66 for standard laminate colors. Refer to page 65 for edge profiles and page 67 for standard edgeband colors.
Grommets: \$26 List Scallops: \$40 List
Refer to page 11 for grommet and scallop cutout detail.

D-Top (DTS)

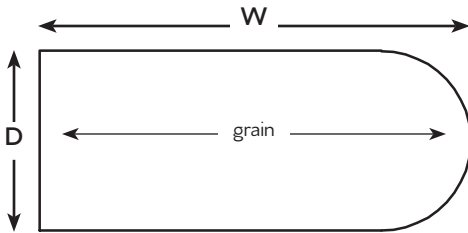

D	W	Model No.	LP	HP
24	x 48	DTS2448	204	282
24	x 60	DTS2460	247	341
24	x 66	DTS2466	283	391
24	x 72	DTS2472	290	400
24	x 84	DTS2484	304	434
30	x 48	DTS3048	239	330
30	x 60	DTS3060	290	399
30	x 66	DTS3066	330	458
30	x 72	DTS3072	338	470
30	x 84	DTS3084	354	504
36	x 48	DTS3648	275	380
36	x 60	DTS3660	330	458
36	x 66	DTS3666	380	527
36	x 72	DTS3672	390	537
36	x 84	DTS3684	403	577

D-Top with Radius (DTR)

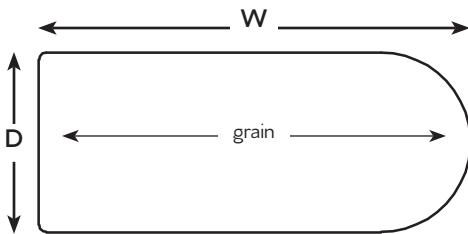

D	W	Model No.	LP	HP
24	x 48	DTR2448	256	352
24	x 60	DTR2460	352	426
24	x 66	DTR2466	355	487
24	x 72	DTR2472	362	500
24	x 84	DTR2484	379	533
30	x 48	DTR3048	304	413
30	x 60	DTR3060	362	500
30	x 66	DTR3066	413	571
30	x 72	DTR3072	424	585
30	x 84	DTR3084	437	625
36	x 48	DTR3648	343	463
36	x 60	DTR3660	413	571
36	x 66	DTR3666	475	658
36	x 72	DTR3672	487	670
36	x 84	DTR3684	501	715

How to Order:

- 1) Select Model Number:
WSS2472
- 2) Specify Laminate Type (LP/HP):
WSS2472-LP
- 3) Add Edge Profile: (See page 65)
WSS2472-LP-S2
- 4) Add Laminate/Edge Color: (See page 66)
WSS2472-LP-S2-U204-Black

Note: Additional upcharge will be applied for Premium and HD Premium colors. Please contact Customer Service for pricing and availability.

Specifications:

- LP (Thermal Fused Laminate) - 1-1/8" thick.
- HP (High Pressure Laminate) - 1-1/4" thick.
- Edgebanding on all edges.
- Sizes value at 'True Dimensions' unless otherwise specified.
- Use with Supports on page 34.

Arc Top (ATS)

D	W	Model No.	LP	HP	
24	x	48	ATS2448	204	282
24	x	60	ATS2460	247	341
24	x	66	ATS2466	283	391
24	x	72	ATS2472	290	400
24	x	84	ATS2484	304	434
30	x	48	ATS3048	239	330
30	x	60	ATS3060	290	399
30	x	66	ATS3066	330	458
30	x	72	ATS3072	339	470
30	x	84	ATS3084	354	504
36	x	48	ATS3648	275	380
36	x	60	ATS3660	330	458
36	x	66	ATS3666	380	525
36	x	72	ATS3672	390	537
36	x	84	ATS3684	403	577

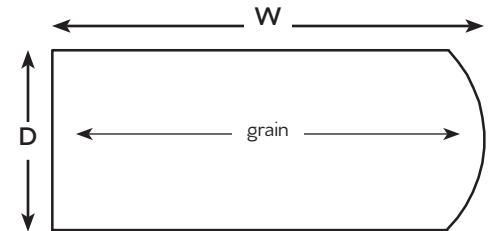

D	W	Model No.	LP	HP	
24	x	48	ATR2448	256	353
24	x	60	ATR2460	310	426
24	x	66	ATR2466	355	487
24	x	72	ATR2472	362	500
24	x	84	ATR2484	377	537
30	x	48	ATR3048	295	413
30	x	60	ATR3060	362	500
30	x	66	ATR3066	413	571
30	x	72	ATR3072	424	589
30	x	84	ATR3084	437	625
36	x	48	ATR3648	631	474
36	x	60	ATR3660	424	571
36	x	66	ATR3666	475	658
36	x	72	ATR3672	487	670
36	x	84	ATR3684	500	715

Arc Top with Radius (ATR)

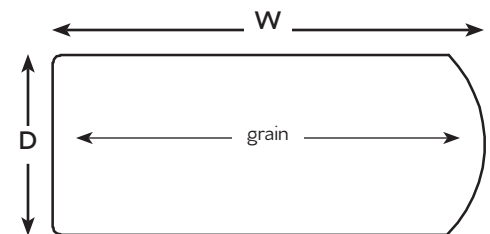

How to Order:

- 1) Select Model Number:
WSS2472
- 2) Specify Laminate Type (LP/HP):
WSS2472-LP
- 3) Add Edge Profile: (See page 65)
WSS2472-LP-S2
- 4) Add Laminate/Edge Color: (See page 66)
WSS2472-LP-S2-U204-Black

Note: Additional upcharge will be applied for Premium and HD Premium colors. Please contact Customer Service for pricing and availability.

Specifications:

- LP (Thermal Fused Laminate) - 1-1/8" thick.
- HP (High Pressure Laminate) - 1-1/4" thick.
- Edgebanding on all edges.
- Sizes value at 'True Dimensions' unless otherwise specified.
- Use with Supports on page 34.

Prices shown are for standard stock laminate. Refer to page 66 for standard laminate colors. Refer to page 65 for edge profiles and page 67 for standard edgeband colors.
Grommets: \$26 List Scallops: \$40 List
Refer to page 11 for grommet and scallop cutout detail.

P-Top (PTSL/PTSR)

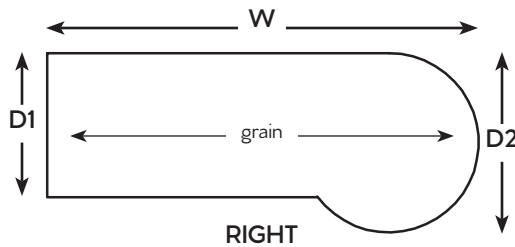
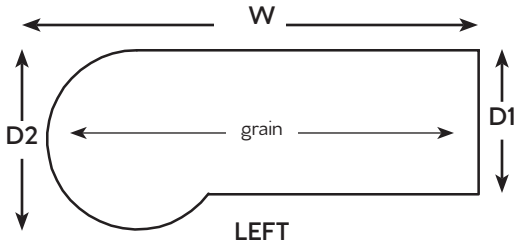

D1	W	D2	Model No.	LP	HP
24	60	30	PTSL246030	290	399
24	66	30	PTSL246630	330	458
24	72	30	PTSL247230	338	470
24	84	30	PTSL248430	354	504
30	60	36	PTSL306036	330	458
30	66	36	PTSL306636	380	525
30	72	36	PTSL307236	390	537
30	84	36	PTSL308436	403	577
36	60	42	PTSL306042	372	518
36	66	42	PTSL306642	433	594
36	72	42	PTSL307242	433	605
36	84	42	PTSL308442	459	646
24	60	30	PTSR246030	301	399
24	66	30	PTSR246630	330	458
24	72	30	PTSR247230	338	470
24	84	30	PTSR248430	354	504
30	60	36	PTSR306036	330	458
30	66	36	PTSR306636	380	525
30	72	36	PTSR307236	390	537
30	84	36	PTSR308436	403	577
36	60	42	PTSR306042	373	517
36	66	42	PTSR306642	432	594
36	72	42	PTSR307242	437	605
36	84	42	PTSR308442	459	646

How to Order:

- 1) Select Model Number:
WSS2472
- 2) Specify Laminate Type (LP/HP):
WSS2472-LP
- 3) Add Edge Profile: (See page 65)
WSS2472-LP-S2
- 4) Add Laminate/Edge Color: (See page 66)
WSS2472-LP-S2-U204-Black

Note: Additional upcharge will be applied for Premium and HD Premium colors. Please contact Customer Service for pricing and availability.

Specifications:

- LP (Thermal Fused Laminate) - 1-1/8" thick.
- HP (High Pressure Laminate) - 1-1/4" thick.
- Edgebanding on all edges.
- Sizes value at 'True Dimensions' unless otherwise specified.
- Use with Supports on page 34.

D1	W	D2	Model No.	LP	HP
24	60	30	PTRL246030	362	499
24	66	30	PTRL246630	413	571
24	72	30	PTRL247230	424	589
24	84	30	PTRL248430	436	625
30	60	36	PTRL306036	413	571
30	66	36	PTRL306636	474	658
30	72	36	PTRL307236	486	669
30	84	36	PTRL308436	499	716
36	60	42	PTRL306042	469	646
36	66	42	PTRL306642	537	743
36	72	42	PTRL307242	546	757
36	84	42	PTRL308442	561	802
24	60	30	PTRR246030	362	499
24	66	30	PTRR246630	413	571
24	72	30	PTRR247230	424	589
24	84	30	PTRR248430	437	625
30	60	36	PTRR306036	413	571
30	66	36	PTRR306636	474	658
30	72	36	PTRR307236	486	669
30	84	36	PTRR308436	499	716
36	60	42	PTRR306042	468	646
36	66	42	PTRR306642	537	743
36	72	42	PTRR307242	546	757
36	84	42	PTRR308442	561	802

P-Top with Radius (PTRL/PTRR)

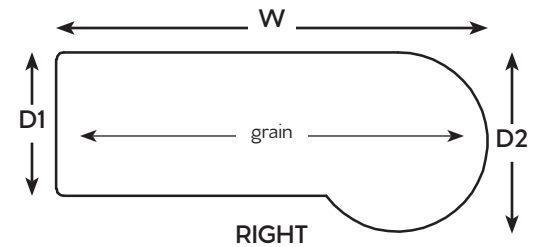
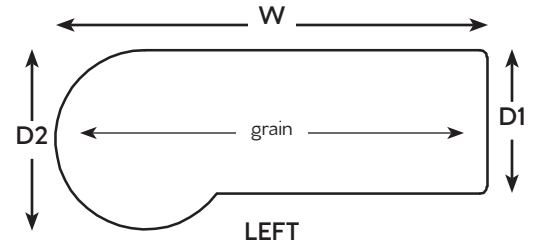

Specifications:

- LP (Thermal Fused Laminate) - 1-1/8" thick.
- HP (High Pressure Laminate) - 1-1/4" thick.
- Edgebanding on all edges.
- Sizes value at 'True Dimensions' unless otherwise specified.
- Use with Supports on page 34.

How to Order:

- 1) Select Model Number:
[WSS2472](#)
- 2) Specify Laminate Type (LP/HP):
[WSS2472-LP](#)
- 3) Add Edge Profile: (See page 65)
[WSS2472-LP-S2](#)
- 4) Add Laminate/Edge Color: (See page 66)
[WSS2472-LP-S2-U204-Black](#)

Note: Additional upcharge will be applied for Premium and HD Premium colors. Please contact Customer Service for pricing and availability.

Corner D-Top (CDSL/CDSR)

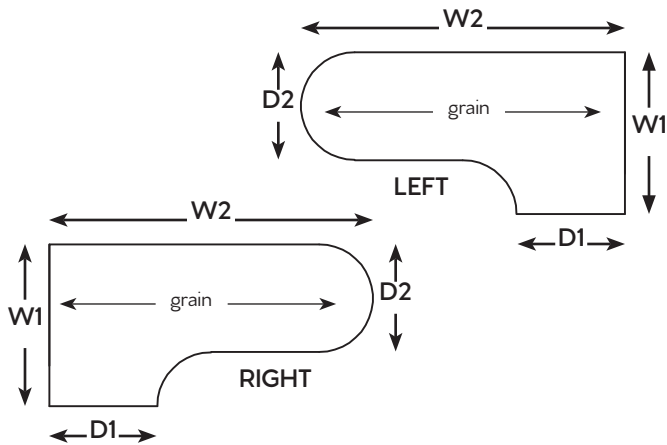

D1	D2	W1	W2	Model No.	LP	HP
24	24	36	60	CDSL243660	402	554
24	24	36	66	CDSL243666	464	642
24	24	36	72	CDSL243672	471	652
30	36	48	60	CDSL244860	416	576
30	36	48	66	CDSL244866	480	663
30	36	48	72	CDSL244872	487	673
24	24	36	60	CDSR243660	402	554
24	24	36	66	CDSR243666	464	642
24	24	36	72	CDSR243672	471	652
30	36	48	60	CDSR244860	416	576
30	36	48	66	CDSR244866	480	663
30	36	48	72	CDSR244872	487	673

Corner D-Top with Radius (CDRL/CDRR)

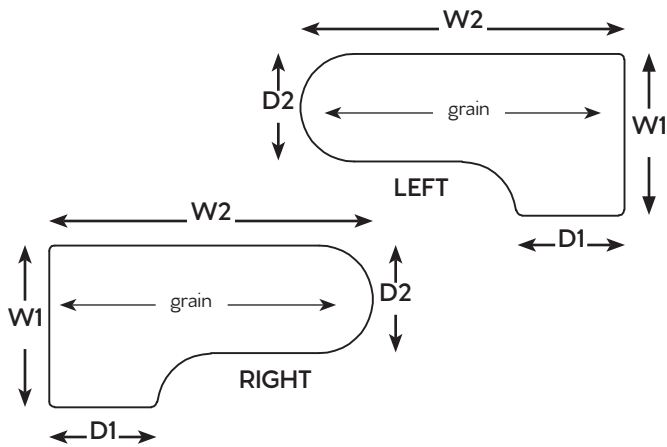

D1	D2	W1	W2	Model No.	LP	HP
24	24	36	60	CDRL243660	502	694
24	24	36	66	CDRL243666	581	802
24	24	36	72	CDRL243672	590	814
30	36	48	60	CDRL244860	521	718
30	36	48	66	CDRL244866	600	830
30	36	48	72	CDRL244872	608	843
24	24	36	60	CDRR243660	502	694
24	24	36	66	CDRR243666	581	802
24	24	36	72	CDRR243672	590	814
30	36	48	60	CDRR244860	521	718
30	36	48	66	CDRR244866	581	838
30	36	48	72	CDRR244872	590	814

How to Order:

- 1) Select Model Number:
WSS2472
- 2) Specify Laminate Type (LP/HP):
WSS2472-LP
- 3) Add Edge Profile: (See page 65)
WSS2472-LP-S2
- 4) Add Laminate/Edge Color: (See page 66)
WSS2472-LP-S2-U204-Black

Note: Additional upcharge will be applied for Premium and HD Premium colors. Please contact Customer Service for pricing and availability.

Specifications:

- LP (Thermal Fused Laminate) - 1-1/8" thick.
- HP (High Pressure Laminate) - 1-1/4" thick.
- Edgebanding on all edges.
- Sizes value at 'True Dimensions' unless otherwise specified.
- Use with Supports on page 34.

Corner P-Top (CPSL/CPSR)

D1	D2	W1	W2	Model No.	LP	HP
24	32	36	60	CPSL243660	470	650
24	32	36	66	CPSL243666	487	757
24	32	36	72	CPSL243672	546	769
30	44	48	60	CPSL304860	484	670
30	44	48	66	CPSL304866	564	777
30	44	48	72	CPSL304872	637	789
24	32	36	60	CPSR243660	470	650
24	32	36	66	CPSR243666	546	757
24	32	36	72	CPSR243672	556	769
30	44	48	60	CPSR304860	484	670
30	44	48	66	CPSR304866	564	777
30	44	48	72	CPSR304872	637	789

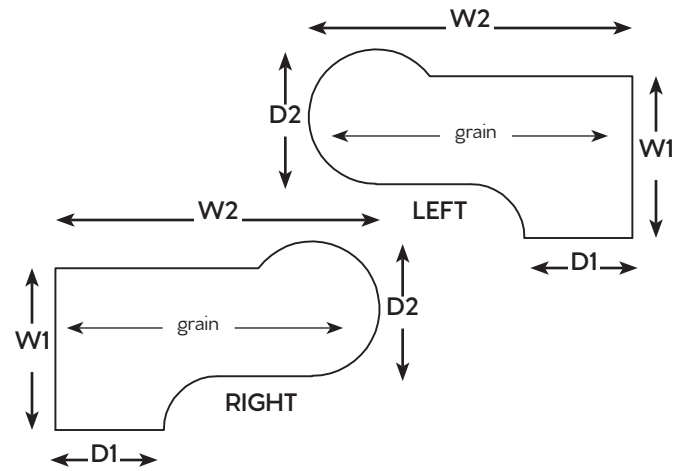

Corner P-Top with Radius (CPRL/CPRR)

D1	D2	W1	W2	Model No.	LP	HP
24	32	36	60	CPRL243660	585	691
24	32	36	66	CPRL243666	684	943
24	32	36	72	CPRL243672	696	958
30	44	48	60	CPRL304860	607	838
30	44	48	66	CPRL304866	703	971
30	44	48	72	CPRL304872	714	985
24	32	36	60	CPRR243660	585	812
24	32	36	66	CPRR243666	684	945
24	32	36	72	CPRR243672	696	958
30	44	48	60	CPRR304860	607	838
30	44	48	66	CPRR304866	703	971
30	44	48	72	CPRR304872	714	985

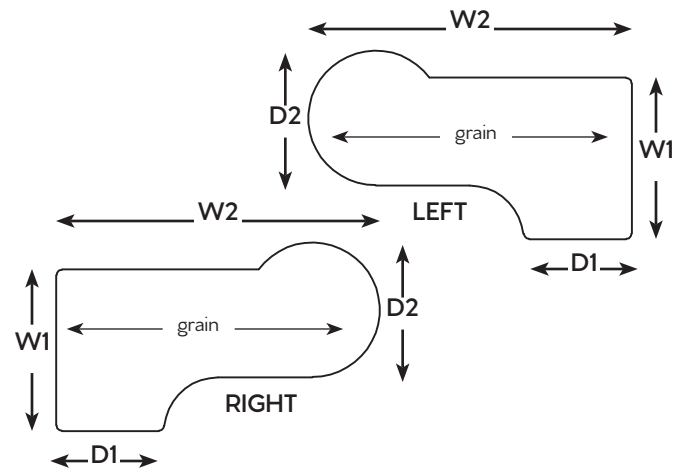

Specifications:

- LP (Thermal Fused Laminate) - 1-1/8" thick.
- HP (High Pressure Laminate) - 1-1/4" thick.
- Edgebanding on all edges.
- Sizes value at 'True Dimensions' unless otherwise specified.
- Use with Supports on page 34.

How to Order:

- 1) Select Model Number:
WSS2472
- 2) Specify Laminate Type (LP/HP):
WSS2472-LP
- 3) Add Edge Profile: (See page 65)
WSS2472-LP-S2
- 4) Add Laminate/Edge Color: (See page 66)
WSS2472-LP-S2-U204-Black

Note: Additional upcharge will be applied for Premium and HD Premium colors. Please contact Customer Service for pricing and availability.

Rectangle Support (RS)

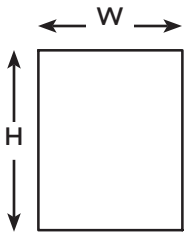

W	H	Model No.	LP	HP	
12	x	27	RS1227	79	112
18	x	27	RS1827	103	145
24	x	27	RS2427	117	167
30	x	27	RS3027	141	200
36	x	27	RS3627	164	233
18	x	34	RS1834	139	177
24	x	34	RS2434	141	208
30	x	34	RS3034	173	248
36	x	34	RS3634	202	278

Curved Support (CS)

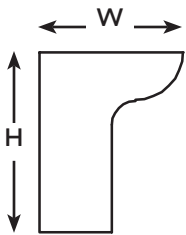

W	H	Model No.	LP	HP	
18	x	27	CS1827	123	158
24	x	27	CS2427	141	180
30	x	27	CS3027	165	213
36	x	27	CS3627	238	244
18	x	34	CS1834	146	191
24	x	34	CS2434	167	217
30	x	34	CS3034	197	256
36	x	34	CS3634	238	295

T Support (TS)

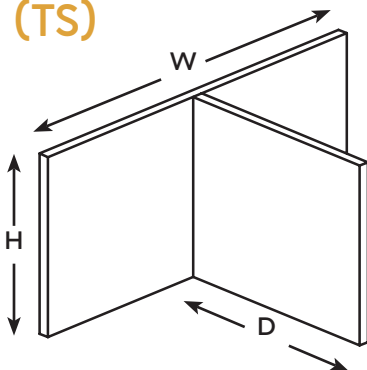

D	W	H	Model No.	LP	HP
12	18	27	TS1218	185	264
12	24	27	TS1224	212	303
12	30	27	TS1230	239	341
12	36	27	TS1236	265	378
18	18	27	TS1818	209	299
18	24	27	TS1824	234	337
18	30	27	TS1830	261	373
18	36	27	TS1836	288	410

Modesty Panel Support (MP)

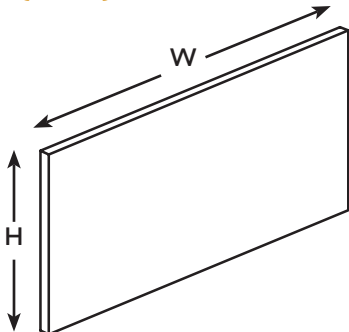

H	W	Model No.	LP	HP	
12	x	24	MP1224	62	89
12	x	36	MP1236	73	103
12	x	42	MP1242	77	111
12	x	48	MP1248	80	116
12	x	54	MP1254	87	124
27	x	24	MP2724	142	202
27	x	36	MP2736	162	231
27	x	42	MP2742	176	250
27	x	48	MP2748	182	259
27	x	54	MP2754	196	279

L Support Left (LSL)

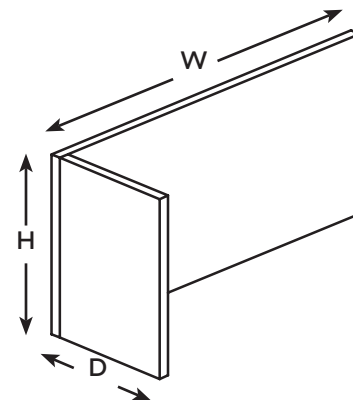

Specifications:

- LP (Thermal Fused Laminate) - 1-1/8" thick.
- HP (High Pressure Laminate) - 1-1/4" thick.
- Edgebanding on all edges.

L Support Right (LSR)

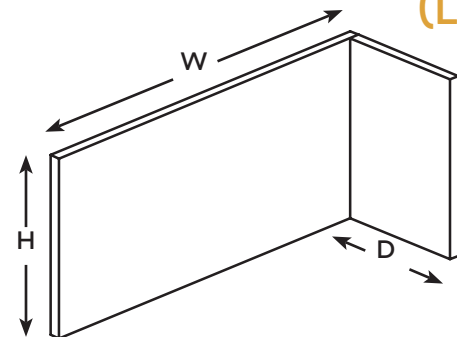

How to Order:

- 1) Select Model Number:
WSS2472
- 2) Specify Laminate Type (LP/HP):
WSS2472-LP
- 3) Add Edge Profile: (See page 65)
WSS2472-LP-S2
- 4) Add Laminate/Edge Color: (See page 66)
WSS2472-LP-S2-U204-Black

Note: Additional upcharge will be applied for Premium and HD Premium colors. Please contact Customer Service for pricing and availability.

D	W	H	Model No.	LP	HP
18	18	27	LSL181827	185	265
18	24	27	LSL182427	209	298
18	30	27	LSL183027	233	331
18	36	27	LSL183627	256	365
18	42	27	LSL184227	279	398
18	48	27	LSL184827	301	432
18	60	27	LSL186027	350	500
18	72	27	LSL187227	409	565
24	18	27	LSL241827	206	293
24	24	27	LSL242427	231	320
24	30	27	LSL243027	256	352
24	36	27	LSL243627	276	395
24	42	27	LSL244227	300	428
24	48	27	LSL244827	323	461
24	60	27	LSL246027	371	480
24	72	27	LSL247227	415	594
30	18	27	LSL301827	228	325
30	24	27	LSL302427	250	358
30	30	27	LSL303027	274	391
30	36	27	LSL303627	297	424
30	42	27	LSL304227	322	458
30	48	27	LSL304827	343	491
30	60	27	LSL306027	391	557
30	72	27	LSL307227	436	624
18	18	27	LSR181827	185	265
18	24	27	LSR182427	209	299
18	30	27	LSR183027	233	331
18	36	27	LSR183627	256	365
18	42	27	LSR184227	279	398
18	48	27	LSR184827	301	432
18	60	27	LSR186027	350	500
18	72	27	LSR187227	409	565
24	18	27	LSR241827	206	293
24	24	27	LSR242427	231	320
24	30	27	LSR243027	253	362
24	36	27	LSR243627	276	395
24	42	27	LSR244227	300	428
24	48	27	LSR244827	323	461
24	60	27	LSR246027	371	58
24	72	27	LSR247227	416	594
30	18	27	LSR301827	228	325
30	24	27	LSR302427	251	358
30	30	27	LSR303027	274	391
30	36	27	LSR303627	297	424
30	42	27	LSR304227	322	458
30	48	27	LSR304827	343	491
30	60	27	LSR306027	391	557
30	72	27	LSR307227	436	624

Prices shown are for standard stock laminate. Refer to page 66 for standard laminate colors. Refer to page 65 for edge profiles and page 67 for standard edgeband colors.

Grommets: \$26 List Scallops: \$40 List
Refer to page 11 for grommet and scallop cutout detail.

Square Table Tops (SQT)

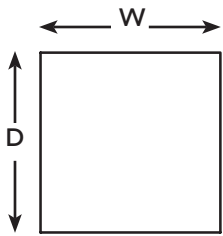

D		W	Model No.	LP	HP
24	x	24	SQT24	112	145
30	x	30	SQT30	158	206
36	x	36	SQT36	213	276
42	x	42	SQT42	336	428
48	x	48	SQT48	342	444
54	x	54	SQT54	503	652
60	x	60	SQT60	542	700

Round Table Tops (RDT)

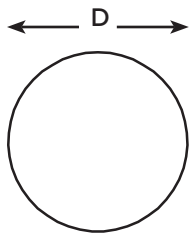

D		Model No.	LP	HP
24		RDT24	128	164
30		RDT30	177	228
36		RDT36	233	305
42		RDT42	354	460
48		RDT48	372	481
60		RDT60	570	717
72		RDT72	694	900

Training Table Tops (TTT)

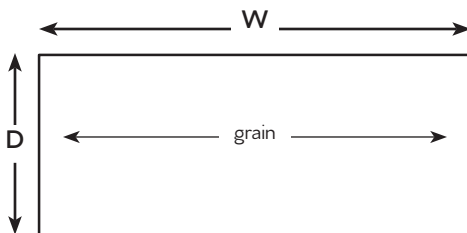

D		W	Model No.	LP	HP
18	x	48	TTT1848	138	195
18	x	60	TTT1860	167	239
18	x	72	TTT1872	200	286
18	x	84	TTT1884	240	342
18	x	96	TTT1896	263	375
24	x	48	TTT2448	160	229
24	x	60	TTT2460	196	279
24	x	72	TTT2472	233	331
24	x	84	TTT2484	285	407
24	x	96	TTT2496	305	436
30	x	48	TTT3048	194	275
30	x	60	TTT3060	237	339
30	x	72	TTT3072	282	399
30	x	84	TTT3084	343	491
30	x	96	TTT3096	367	528

How to Order:

- 1) Select Model Number:
WSS2472
- 2) Specify Laminate Type (LP/HP):
WSS2472-LP
- 3) Add Edge Profile: (See page 65)
WSS2472-LP-S2
- 4) Add Laminate/Edge Color: (See page 66)
WSS2472-LP-S2-U204-Black

Note: Additional upcharge will be applied for Premium and HD Premium colors. Please contact Customer Service for pricing and availability.

Rectangle Table Tops (RTT)

D	W	Model No.	LP	HP
36	x 72	RTT3672	425	552
36	x 96	RTT3696	505	721
42	x 72	RTT4272	441	628
42	x 84	RTT4284	507	724
42	x 96	RTT4296	574	820
42	x 120	RTT42120	707	1011
48	x 72	RTT4872	493	705
48	x 96	RTT4896	644	919
48	x 120	RTT48120	728	1133
48	x 144	RTT48144	944	1348
60	x 96	RTT6096	783	1118
60	x 120	RTT60120	965	1375
60	x 144	RTT60144	1146	1613

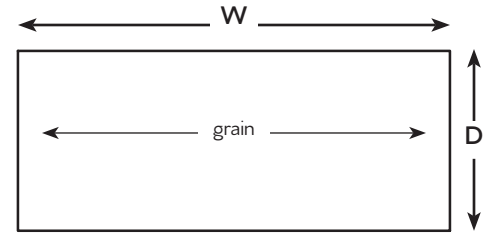

D	W	Model No.	LP	HP
36	x 72	RCT3672	447	638
36	x 96	RCT3696	578	825
42	x 72	RCT4272	504	719
42	x 84	RCT4284	578	825
42	x 96	RCT4296	651	930
42	x 120	RCT42120	798	1141
48	x 72	RCT4872	560	801
48	x 96	RCT4896	724	1034
48	x 120	RCT48120	887	1267
48	x 144	RCT48144	1049	1499
60	x 96	RCT6096	869	1242
60	x 120	RCT60120	1064	1521
60	x 144	RCT60144	1260	1799

Radius Corner Table Tops (RCT)

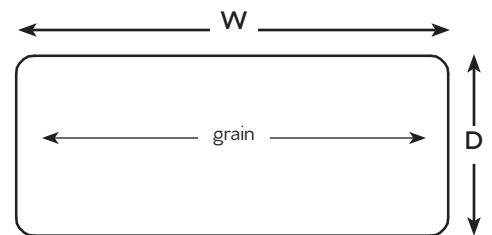

Specifications:

- LP (Thermal Fused Laminate) - 1-1/8" thick
- HP (High Pressure Laminate) - 1-1/4" thick
- PolyBak on the underside
- Edgebanding on all edges
- For a (2) piece top, add \$100 List for spline joint and tight joint fastner.
- Add \$220 List for (2) anti-sag bars.

How to Order:

- 1) Select Model Number:
WSS2472
- 2) Specify Laminate Type (LP/HP):
WSS2472-LP
- 3) Add Edge Profile: (See page 65)
WSS2472-LP-S2
- 4) Add Laminate/Edge Color: (See page 66)
WSS2472-LP-S2-U204-Black

Note: Additional upcharge will be applied for Premium and HD Premium colors. Please contact Customer Service for pricing and availability.

Prices shown are for standard stock laminate. Refer to page 66 for standard laminate colors. Refer to page 65 for edge profiles and page 67 for standard edgeband colors.

Grommets: \$26 List Scallops: \$40 List
Refer to page 11 for grommet and scallop cutout detail.

Oval Table Tops (OTT)

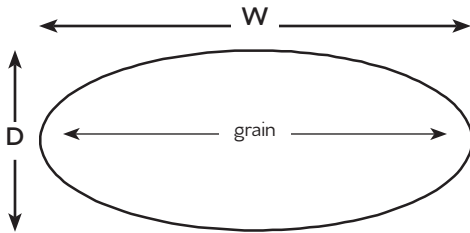

Racetrack Table Tops (RCK)

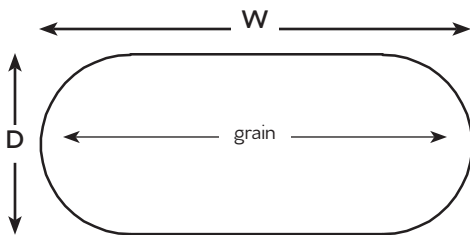

Boat Shape Table Tops (BTT)

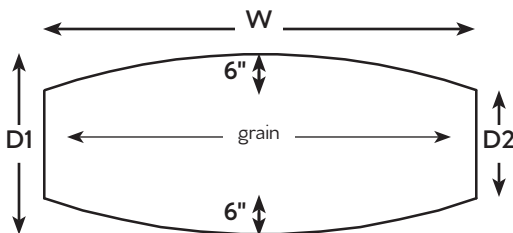

Specifications:

- LP (Thermal Fused Laminate) - 1-1/8" thick.
- HP (High Pressure Laminate) - 1-1/4" thick.
- Edgebanding on all edges.
- Sizes value at 'True Dimensions' unless otherwise specified.
- Use with Supports on page 34.

D		W	Model No.	LP	HP
36	x	72	OTT3672	447	638
36	x	96	OTT3696	577	825
42	x	72	OTT4272	504	719
42	x	84	OTT4284	578	825
42	x	96	OTT4296	651	930
42	x	120	OTT42120	798	1141
48	x	72	OTT4872	560	801
48	x	96	OTT4896	724	1034
48	x	120	OTT48120	888	1267
48	x	144	OTT48144	1049	2104
60	x	96	OTT6096	869	1242
60	x	120	OTT60120	1064	1521
60	x	144	OTT60144	1260	1966

D		W	Model No.	LP	HP
36	x	72	RCK3672	447	638
36	x	96	RCK3696	578	825
42	x	72	RCK4272	504	719
42	x	84	RCK4284	578	825
42	x	96	RCK4296	651	930
42	x	120	RCK42120	798	1141
48	x	72	RCK4872	560	801
48	x	96	RCK4896	724	1034
48	x	120	RCK48120	888	1267
48	x	144	RCK48144	1049	2104
60	x	96	RCK6096	869	1242
60	x	120	RCK60120	1064	1521
60	x	144	RCK60144	1260	1966

D1	D2	W	Model No.	LP	HP
36	24	72	BTT3672	447	638
36	24	96	BTT3696	578	825
42	30	72	BTT4272	504	719
42	30	84	BTT4284	578	825
42	30	96	BTT4296	651	930
42	30	120	BTT42120	798	1141
48	36	72	BTT4872	560	801
48	36	96	BTT4896	724	1034
48	36	120	BTT48120	888	1267
48	36	144	BTT48144	1049	2104
60	48	96	BTT6096	869	1242
60	48	120	BTT60120	1064	1521
60	48	144	BTT60144	1260	1966

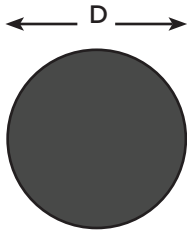

Round Tops

Diameter		Seating
24	=	2
30	=	2
36	=	4
42	=	4
48	=	5
60	=	7
72	=	8

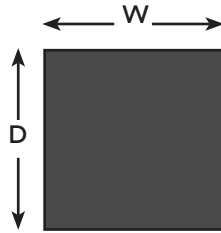

Square Tops

D	W		Seating
24	24	=	2
30	30	=	2
36	36	=	4
42	42	=	4
48	48	=	4
54	54	=	8
60	60	=	8

Table Seating Capacity

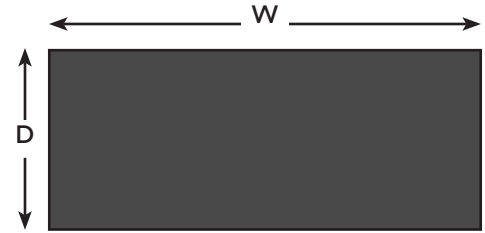

Rectangle Tops

D	W	Seating	D	W	Seating
18	48	= 2	36	72	= 6
18	60	= 2	36	96	= 8
18	72	= 3	42	72	= 6
18	84	= 3	42	84	= 6
18	96	= 4	42	96	= 8
24	48	= 2	42	120	= 10
24	60	= 2	48	72	= 6
24	72	= 3	48	96	= 8
24	84	= 3	48	120	= 10
24	96	= 4	48	144	= 12
30	48	= 4	60	96	= 10
30	60	= 4	60	120	= 12
30	72	= 6	60	144	= 14
30	84	= 6			
30	96	= 8			

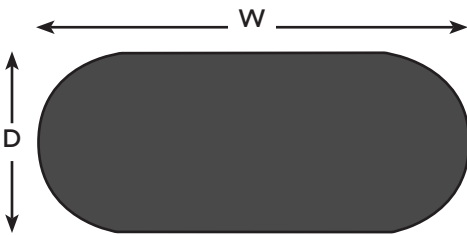

Racetrack Tops

D	W		Seating
36	72	=	6
36	96	=	8
42	72	=	6
42	84	=	6
42	96	=	8
42	120	=	10
48	72	=	6
48	96	=	8
48	120	=	10
48	144	=	12
60	96	=	10
60	120	=	12
60	144	=	14

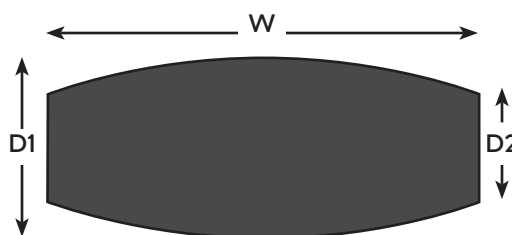

Boat Tops

D1	D2	W	Seating
36	24	72	= 6
36	24	96	= 8
42	30	72	= 6
42	30	84	= 6
42	30	96	= 8
42	30	120	= 10
48	36	72	= 6
48	36	96	= 8
48	36	120	= 10
48	36	144	= 12
60	48	96	= 10
60	48	120	= 12
60	48	144	= 14

How to Order:

- 1) Select Model Number:
WSS2472
- 2) Specify Laminate Type (LP/HP):
WSS2472-LP
- 3) Add Edge Profile: (See page 65)
WSS2472-LP-S2
- 4) Add Laminate/Edge Color: (See page 66)
WSS2472-LP-S2-U204-Black

Note: Additional upcharge will be applied for Premium and HD Premium colors. Please contact Customer Service for pricing and availability.

Prices shown are for standard stock laminate. Refer to page 66 for standard laminate colors. Refer to page 65 for edge profiles and page 67 for standard edgeband colors.

Grommets: \$26 List Scallops: \$40 List
Refer to page 11 for grommet and scallop cutout detail.

Occasional Tables

Cube Table

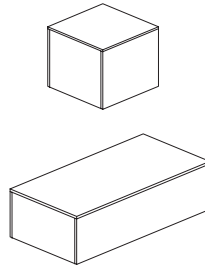

W	D	H	Model No.	LP	HP
20	x 20	x 20	OTC202020	583	846
24	x 24	x 20	OTC242420	605	862
24	x 48	x 16	OTC244816	755	1078
36	x 36	x 16	OTC363616	785	1122

Cube Table with Base

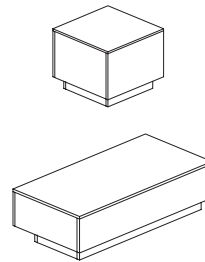

W	D	H	Model No.	LP	HP
20	x 20	x 20	OTCB202020	634	905
24	x 24	x 20	OTCB242420	655	935
24	x 48	x 16	OTCB244816	806	1151
36	x 36	x 16	OTCB363616	835	1194

Specifications:

- LP (Thermal Fused Laminate) - 1-1/8" thick
- HP (High Pressure Laminate) - 1-1/4" thick
- All Custom Crafters furniture is shipped fully assembled, unless otherwise noted.
- Custom Crafters is manufactured using scratch, spill and stain resistant high pressure laminate (HP) or Thermal Fused Laminate (LP). See page 66 for a listing of our standard laminate colors.
- Custom Crafters uses M-3 CARB2 compliant industrial grade particleboard for all furniture with moisture resistant PolyBak on the underside.
- Custom sizes are available. Please contact customer service for pricing and availability.

How to Order:

- 1) Select Model Number:
LF4
- 2) Specify Laminate Type (LP/HP):
LF4-LP
- 3) Add Laminate Color: (See page 66)
LF4-LP-WF270

Note: Additional upcharge will be applied for Premium and HD Premium colors. Please contact Customer Service for pricing and availability.

Prices shown are for standard stock laminate. Refer to page 66 for standard laminate colors. Refer to page 65 for edge profiles and page 67 for standard edgeband colors.

Grommets: \$26 List Scallops: \$40 List
Refer to page 11 for grommet and scallop cutout detail.

Drum Table

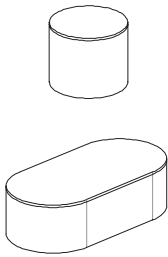

W	D	H	Model No.	HP		
20 dia.	x	20	OTD2020	1133		
24 dia.	x	20	OTD2420	1172		
36 dia.	x	16	OTD3616	1606		
24	x	48	x	16	OTD244816	3075

Drum Table with Base

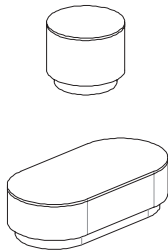

W	D	H	Model No.	HP		
20 dia.	x	20	OTDB2020	1095		
24 dia.	x	20	OTDB2420	1120		
36 dia.	x	16	OTDB3616	1672		
24	x	48	x	16	OTDB244816	3146

Occasional Tables

Specifications:

- LP (Thermal Fused Laminate) - 1-1/8" thick
- HP (High Pressure Laminate) - 1-1/4" thick
- All Custom Crafters furniture is shipped fully assembled, unless otherwise noted.
- Custom Crafters is manufactured using scratch, spill and stain resistant high pressure laminate (HP) or Thermal Fused Laminate (LP). See page 66 for a listing of our standard laminate colors.
- Custom Crafters uses M-3 CARB2 compliant industrial grade particleboard for all furniture with moisture resistant PolyBak on the underside.
- Custom sizes are available. Please contact customer service for pricing and availability.

How to Order:

- 1) Select Model Number:
LF4
- 2) Specify Laminate Type (LP/HP):
LF4-LP
- 3) Add Laminate Color: (See page 66)
LF4-LP-WF270

Note: Additional upcharge will be applied for Premium and HD Premium colors. Please contact Customer Service for pricing and availability.

Prices shown are for standard stock laminate. Refer to page 66 for standard laminate colors. Refer to page 65 for edge profiles and page 67 for standard edgeband colors.
Grommets: \$26 List Scallops: \$40 List
Refer to page 11 for grommet and scallop cutout detail.

H Base (HB)

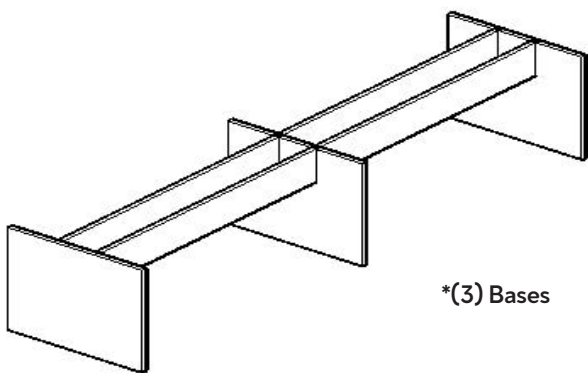
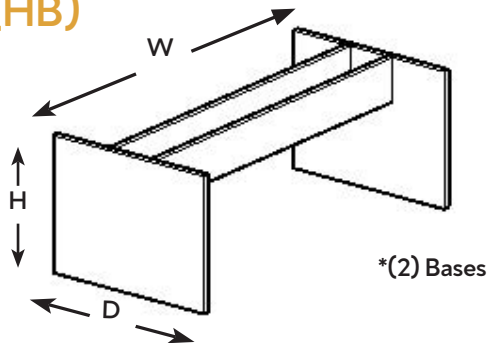

X Base (XB)

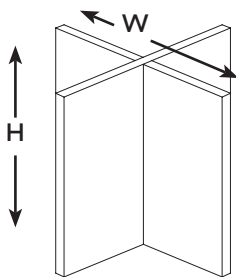

Specifications:

- LP (Thermal Fused Laminate) - 1-1/8" thick
- HP (High Pressure Laminate) - 1-1/4" thick
- laminate on two side
- Levelers included

D	W	H	Model No.	LP	HP
18	36	27	HB1836	351	503
18	48	27	HB1848	406	579
18	72	27	HB1872	508	754
18	96	27	HB1896	655	915
24	36	27	HB2436	371	531
24	48	27	HB2448	426	608
24	72	27	HB2472	497	709
24	96	27	HB2496	867	810
30	72	27	HB3072	551	786
30	96	27	HB3096	621	887

Please note: Dimensions are for bases beneath worksurface and not for the Worksurfaces itself. Bases are used with table tops on pages 36-38.

*Bases are recommended to be used with the following worksurfaces:

Base Size	Worksurface	Bases	Base Size	Worksurface	Bases
18x36	= 36x72	= 2	24x36	= 48x72	= 2
18x48	= 36x96	= 2	24x48	= 48x96	= 2
18x36	= 42x72	= 2	24x72	= 48x120	= 2
18x48	= 42x84	= 2	24x96	= 48x144	= 3
18x48	= 42x96	= 2	30x72	= 60x120	= 2
18x72	= 42x120	= 2	30x96	= 60x144	= 3
18x96	= 42x144	= 3			

W	H	Model No.	LP	HP	
12	x	27	XB12	160	229
18	x	27	XB18	222	319
20	x	27	XB20	240	343
24	x	27	XB24	274	391
30	x	27	XB30	323	461
36	x	27	XB36	372	531

Please note: Dimensions are for bases beneath worksurface and not for the Worksurfaces itself. Bases are used with table tops on pages 36-38.

*Bases are recommended to be used with the following worksurfaces:

Base Size		Round Table Tops Diameter		Bases
18	=	30 → 36	=	1
24	=	42 → 48	=	1
30	=	60	=	1
36	=	72	=	1

Base Size		Worksurfaces W x L		Bases
18	=	36 x 72 → 96	=	2
24	=	42 → 48 x 72 → 120	=	2
24	=	42 → 48 x 144	=	3
30	=	60 x 96 → 120	=	2
30	=	60 x 144	=	3

Prices shown are for standard stock laminate. Refer to page 66 for standard laminate colors. Refer to page 65 for edge profiles and page 67 for standard edgeband colors.

Grommets: \$26 List Scallops: \$40 List
Refer to page 11 for grommet and scallop cutout detail.

D	W	H	Model No.	LP	HP
18	48	27	BHB1848	1244	1776
18	72	27	BHB1872	1341	1913
24	48	27	BHB2448	1368	1955
24	72	27	BHB2472	1476	2105
24	96	27	BHB2496	1527	2180
30	72	27	BHB3072	1496	2137
30	96	27	BHB3096	1601	2286
30	120	27	BHB30120	1696	2422

Please note: Dimensions are for bases beneath worksurface and not for the Worksurfaces itself. Bases are used with table tops on pages 36-38. Box H Base includes 12"H trough with 6" gap for wire management. Removable Access Door option available at \$115.00 List.

*Bases are recommended to be used with the following worksurfaces:

Base Size	Worksurface	Bases
18x48	= 48x96	= 2
18x72	= 48x120	= 2
30x72	= 60x120	= 2
30x96	= 60x144	= 3
30x120	= 60x168	= 3

D	H	Model No.	HP
18	27	DB18	1162
20	27	DB24	1247
30	27	DB30	3055
36	27	DB36	3383

Please note: Dimensions are for bases beneath worksurface and not for the Worksurfaces itself. Bases are used with table tops on pages 36-38. Removable Access Door option available at \$125.00 List.

*Bases are recommended to be used with the following worksurfaces:

Base Size	Round Table Tops Diameter	Bases
18	= 30 → 36	= 1
20	= 42 → 48	= 1
30	= 60	= 1
36	= 72	= 1

Base Size	Worksurfaces W x L	Bases
18	= 36 x 72 → 96	= 2
20	= 42 → 48 x 72 → 120	= 2
20	= 42 → 48 x 144	= 3
30	= 60 x 96 → 120	= 2
30	= 60 x 144	= 3

Box H Base (BHB)

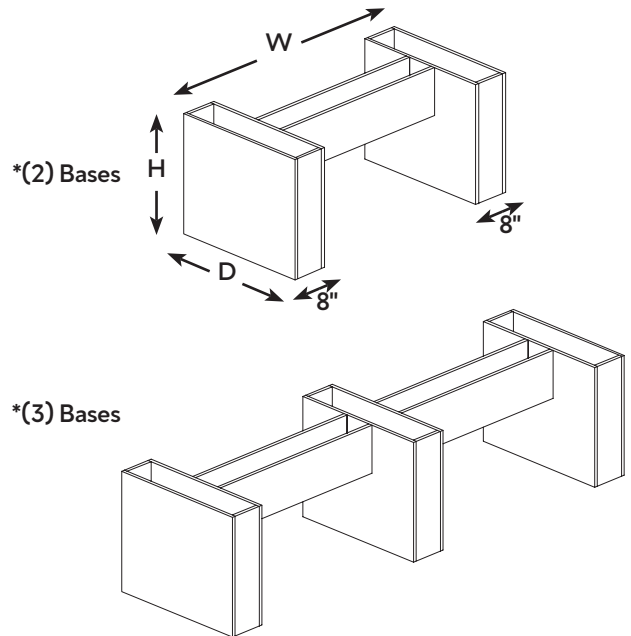

Drum Base (DB)

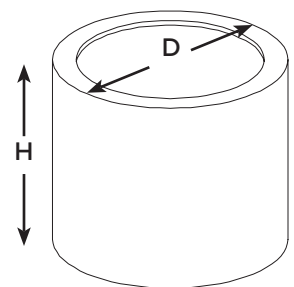

Specifications:

- LP (Thermal Fused Laminate) - 1-1/8" thick
- HP (High Pressure Laminate) - 1-1/4" thick
- laminate on two side
- Levelers included

Prices shown are for standard stock laminate. Refer to page 66 for standard laminate colors. Refer to page 65 for edge profiles and page 67 for standard edgeband colors. Grommets: \$26 List Scallops: \$40 List Refer to page 11 for grommet and scallop cutout detail.

Typicals 1-6

Typical 1

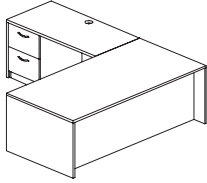

Part	Product	Dimension	Model No.	LP	HP
A	Rectangle Desk with Single Full Pedestal	72x36	RDR-BBF-7236	1840	2629
B	Desk Return with Full Pedestal : FF	48x24	DRL-FF-48	1036	1477

Total List 2876 4106

Typical 2

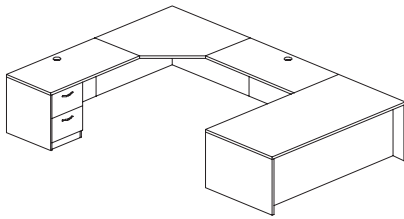

Part	Product	Dimension	Model No.	LP	HP
A	Rectangle Desk with Single Full Pedestal	72x36	RDR-BBF-7236	1840	2629
B	Desk Return Shell Only	48x24	DR-S-48	424	605
C	Straight Corner	42x42	SC2442	256	365
D	Desk Return with Full Pedestal : FF	48x24	DRL-FF-48	1036	1477

Total List 3556 5076

Typical 3

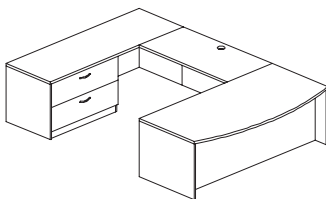

Part	Product	Dimension	Model No.	LP	HP
A	Bow Front Desk with Single Full Pedestal : BBF	72x36	BDR-BBF-72	1888	2696
B	Desk Return Shell Only	48x24	DR-S-48	424	605
C	Credenza with Single Lateral File	72x24	CDZL-LF-72	1586	2266

Total List 3898 5567

Typicals 1-6

Typical 4

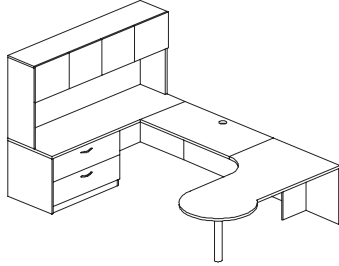

Part	Product	Dimension	Model No.	LP	HP
A	Corner P-Top	72x36	CPKR-24323672	1112	1642
B	Desk Return Shell Only	48x24	DR-S-48	424	605
C	Credenza with Single Lateral File	72x24	CDZL-LF-72	1586	2265
D	Hutch	72x36	H-72	1432	2054

Total List 4561 6566

Typical 5

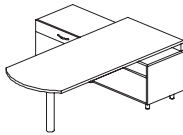

Part	Product	Dimension	Model No.	LP	HP
A	Arc Top Peninsula Desk	72x36	ATK-7236	910	1299
B	Low Storage Unit	72x20	LOSL-72	1531	1988

Total List 2441 3287

Typical 6

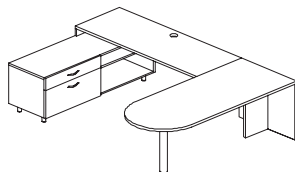

Part	Product	Dimension	Model No.	LP	HP
A	D-Top Peninsula Desk	72x30	DTK-7230	822	1174
B	Desk Return Shell Only	66x24	DR-S-66	585	835
C	Low Storage Unit	72x20	LOSL-72	1840	26229

Total List 3247 4638

Prices shown are for standard stock laminate. Refer to page 66 for standard laminate colors. Refer to page 65 for edge profiles and page 67 for standard edgeband colors.
 Grommets: \$26 List Scallops: \$40 List
 Refer to page 11 for grommet and scallop cutout detail.

Rectangle Desk (RD)

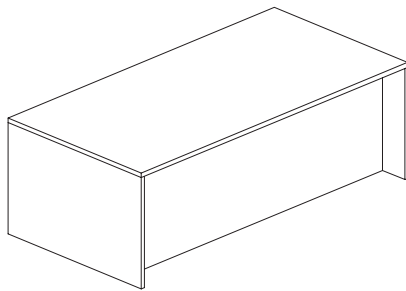

Shell Only

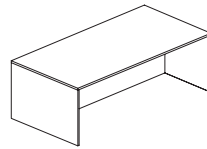

W	D	Model No.	LP	HP	DWG
48	x 30	RD-S-4830	771	1101	76.0
60	x 30	RD-S-6030	876	1251	77.0
66	x 30	RD-S-6630	928	1326	78.0
72	x 30	RD-S-7230	978	1398	79.0
60	x 36	RD-S-6036	968	1382	80.0
72	x 36	RD-S-7236	1080	1543	81.0

With Double Full Pedestals : BBF & FF

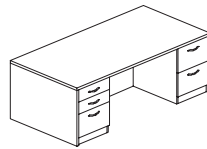

W	D	Model No.	LP	HP	DWG
60	x 30	RD-BBF-FF-6030	2396	3171	82.0
66	x 30	RD-BBF-FF-6630	2448	3240	83.0
72	x 30	RD-BBF-FF-7230	2500	3306	84.0
60	x 36	RD-BBF-FF-6036	2489	3292	85.0
72	x 36	RD-BBF-FF-7236	2603	3441	86.0
60	x 30	RD-FF-BBF-6030	2396	31741	87.0
66	x 30	RD-FF-BBF-6630	2448	3240	88.0
72	x 30	RD-FF-BBF-7230	2500	3306	89.0
60	x 36	RD-FF-BBF-6036	2489	3292	90.0
72	x 36	RD-FF-BBF-7236	2603	3441	91.0

Specifications:

- LP (Thermal Fused Laminate) - 1-1/8" thick
- HP (High Pressure Laminate) - 1-1/4" thick
- All Custom Crafters furniture is shipped fully assembled, unless otherwise noted.
- Custom Crafters is manufactured using scratch, spill and stain resistant high pressure laminate (HP) or Thermal Fused Laminate (LP). See page 66 for a listing of our standard laminate colors.
- Custom Crafters uses M-3 CARB2 compliant industrial grade particleboard for all furniture with moisture resistant PolyBak on the underside.
- Desk includes 6" recessed full modesty panel and locks.
- Pedestal drawers operate on precision full extension slides. Hang rails are provided in all file drawers for front-to-back letter filing.
- Edge is 2mm PVC. See page 67 for colors.
- Full pedestals are 16-1/4"Wx23"Lx27-5/8"H.
- 3/4 pedestals are 16-1/4"Wx23"Lx18-1/2"H.
- Lateral files are 36"Wx23"Lx27-5/8"H.

With Double 3/4 Pedestals : BF & BF

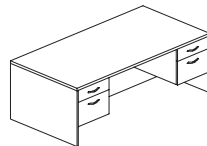

W	D	Model No.	LP	HP	DWG
60	x 30	RD-BF-BF-6030	2036	2911	92.0
66	x 30	RD-BF-BF-6630	2088	2981	93.0
72	x 30	RD-BF-BF-7230	2140	3057	94.0
60	x 36	RD-BF-BF-6036	2129	3040	95.0
72	x 36	RD-BF-BF-7236	2242	3202	96.0

With Single Full Pedestal : BBF

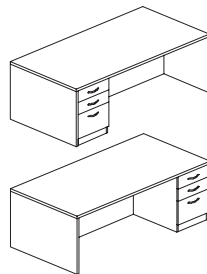

W	D	Model No.	LP	HP	DWG
48	x 30	RDL-BBF-4830	1531	2189	97.0
60	x 30	RDL-BBF-6030	1636	2338	98.0
66	x 30	RDL-BBF-6630	1689	2411	99.0
72	x 30	RDL-BBF-7230	1739	2484	100.0
60	x 36	RDL-BBF-6036	1728	2468	101.0
72	x 36	RDL-BBF-7236	1840	2629	102.0
48	x 30	RDR-BBF-4830	1531	2189	103.0
60	x 30	RDR-BBF-6030	1636	2338	104.0
66	x 30	RDR-BBF-6630	1689	2411	105.0
72	x 30	RDR-BBF-7230	1739	2484	106.0
60	x 36	RDR-BBF-6036	1728	2468	107.0
72	x 36	RDR-BBF-7236	1840	2629	108.0

With Single 3/4 Pedestal : BF

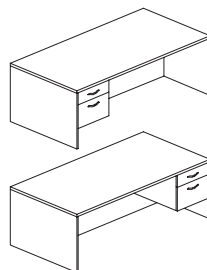

W	D	Model No.	LP	HP	DWG
48	x 30	RDL-BF-4830	1352	1931	109.0
60	x 30	RDL-BF-6030	1456	2081	110.0
66	x 30	RDL-BF-6630	1508	2153	111.0
72	x 30	RDL-BF-7230	1560	2220	112.0
60	x 36	RDL-BF-6036	1549	2212	113.0
72	x 36	RDL-BF-7236	1660	2373	114.0
48	x 30	RDR-BF-4830	1352	1931	115.0
60	x 30	RDR-BF-6030	1456	2081	116.0
66	x 30	RDR-BF-6630	1508	2153	117.0
72	x 30	RDR-BF-7230	1560	2228	118.0
60	x 36	RDR-BF-6036	1549	2212	119.0
72	x 36	RDR-BF-7236	1660	2373	120.0

How to Order:

- 1) Select Model Number:
RD-BBF-FF-7236
- 2) Specify Laminate Type (LP/HP):
RD-BBF-FF-7236-LP
- 3) Add Laminate/Edge Color: (See page 66)
RD-BBF-FF-7236-LP-WF236-Shadow Oak

Note: Additional upcharge will be applied for Premium and HD Premium colors. Please contact Customer Service for pricing and availability.

Prices shown are for standard stock laminate. Refer to page 66 for standard laminate colors. Refer to page 65 for edge profiles and page 67 for standard edgeband colors.

Grommets: \$26 List Scallops: \$40 List
Refer to page 11 for grommet and scallop cutout detail.

Shell Only

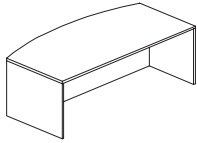

W	D	Model No.	LP	HP	DWG
60	x 36	BD-S-60	1005	1436	121.0
72	x 36	BD-S-72	1126	1606	122.0

Bow Front Desk (BD)

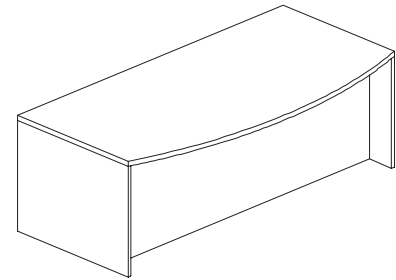

With Double Full Pedestals : BBF & FF

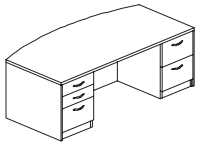

W	D	Model No.	LP	HP	DWG
60	x 36	BD-BBF-FF-60	2527	3616	123.0
72	x 36	BD-BBF-FF-72	2649	3783	124.0
60	x 36	BD-FF-BBF-60	2527	3609	125.0
72	x 36	BD-FF-BBF-72	2649	3783	126.0

With Double 3/4 Pedestals : BF & BF

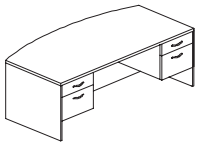

W	D	Model No.	LP	HP	DWG
60	x 36	BD-BF-BF-60	2165	3094	127.0
72	x 36	BD-BF-BF-72	2286	3267	128.0

With Single Full Pedestal : BBF

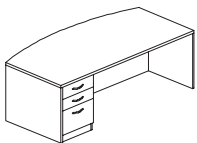

W	D	Model No.	LP	HP	DWG
60	x 36	BDL-BBF-60	1766	2521	129.0
72	x 36	BDL-BBF-72	1888	2696	130.0

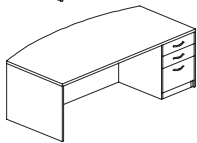

60	x 36	BDR-BBF-60	1766	2521	131.0
72	x 36	BDR-BBF-72	1888	2696	132.0

With Single 3/4 Pedestal : BF

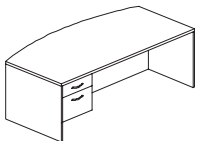

W	D	Model No.	LP	HP	DWG
60	x 36	BDL-BF-60	1586	2265	133.0
72	x 36	BDL-BF-72	1707	2440	134.0

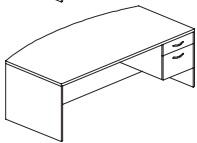

60	x 36	BDR-BF-60	1586	2265	135.0
72	x 36	BDR-BF-72	1707	2440	136.0

Specifications:

- LP (Thermal Fused Laminate) - 1-1/8" thick
- HP (High Pressure Laminate) - 1-1/8"
- All Custom Crafters Furniture is shipped fully assembled, unless otherwise noted.
- Custom Crafters is manufactured using scratch, spill and stain resistant high pressure laminate (HP) or Thermal Fused Laminate (LP). See page 66 for a listing of our standard laminate colors.
- Custom Crafters uses M-3 CARB2 compliant industrial grade particleboard for all furniture with moisture resistant PolyBak on the underside.
- Desk includes 6" recessed full modesty panel and locks.
- Pedestal drawers operate on precision full extension slides. Hang rails are provided in all file drawers for front-to-back letter filing.
- Edge is 2mm PVC. See page 67 for colors.
- Full pedestals are 16-1/4"Wx23"Lx27-5/8"H.
- 3/4 pedestals are 16-1/4"Wx23"Lx18-1/2"H.
- Lateral files are 36"Wx23"Lx27-5/8"H.

How to Order:

- 1) Select Model Number:
RD-BBF-FF-7236
- 2) Specify Laminate Type (LP/HP):
RD-BBF-FF-7236-LP
- 3) Add Laminate/Edge Color: (See page 66)
RD-BBF-FF-7236-LP-WF236-Shadow

Note: Additional upcharge will be applied for Premium and HD Premium colors. Please contact Customer Service for pricing and availability.

Prices shown are for standard stock laminate. Refer to page 66 for standard laminate colors. Refer to page 65 for edge profiles and page 67 for standard edgeband colors.
Grommets: \$26 List Scallops: \$40 List
Refer to page 11 for grommet and scallop cutout detail.

Returns (DR)

Shell Only

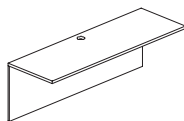

W	D	Model No.	LP	HP
42	x 24	DR-S-42	424	550
48	x 24	DR-S-48	424	550
60	x 24	DR-S-60	457	595
66	x 24	DR-S-66	586	759
72	x 24	DR-S-72	653	847

With Panel : P

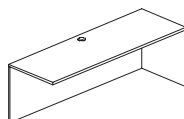
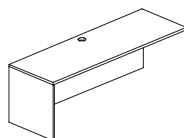

W	D	Model No.	LP	HP
42	x 24	DRL-P-42	555	701
48	x 24	DRL-P-48	555	701
60	x 24	DRL-P-60	577	747
66	x 24	DRL-P-66	702	912
72	x 24	DRL-P-72	770	999
42	x 24	DRR-P-42	555	701
48	x 24	DRR-P-48	565	701
60	x 24	DRR-P-60	577	747
66	x 24	DRR-P-66	702	912
72	x 24	DRR-P-72	770	999

Specifications:

- LP (Thermal Fused Laminate) - 1-1/8" thick
- HP (High Pressure Laminate) - 1-1/4" thick
- All Custom Crafters furniture is shipped fully assembled, unless otherwise noted.
- Custom Crafters is manufactured using scratch, spill and stain resistant high pressure laminate (HP) or Thermal Fused Laminate (LP). See page 66 for a listing of our standard laminate colors.
- Custom Crafters uses M-3 CARB2 compliant industrial grade particleboard for all furniture with moisture resistant PolyBak on the underside.
- Desk includes 6" recessed full modesty panel and locks.
- Pedestal drawers operate on precision full extension slides. Hang rails are provided in all file drawers for front-to-back letter filing.
- Edge is 2mm PVC. See page 67 for colors.
- Full pedestals are 16-1/4"Wx23"Lx27-5/8"H.
- 3/4 pedestals are 16-1/4"Wx23"Lx18-1/2"H.
- Lateral files are 36"Wx23"Lx27-5/8"H.

With Full Pedestal : FF

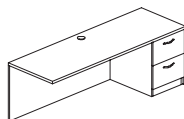
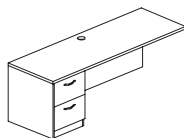

W	D	Model No.	LP	HP
42	x 24	DRL-FF-42	1037	1343
48	x 24	DRL-FF-48	1037	1343
60	x 24	DRL-FF-60	1072	1389
66	x 24	DRL-FF-66	1197	1553
72	x 24	DRL-FF-72	1263	1641
42	x 24	DRR-FF-42	1037	1343
48	x 24	DRR-FF-48	1045	1343
60	x 24	DRR-FF-60	1072	1389
66	x 24	DRR-FF-66	1197	1553
72	x 24	DRR-FF-72	1263	1641

With 3/4 Pedestal : BF

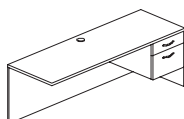
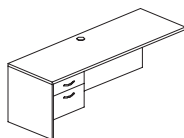

W	D	Model No.	LP	HP
42	x 24	DRL-BF-42	918	1192
48	x 24	DRL-BF-48	918	1192
60	x 24	DRL-BF-60	973	1238
66	x 24	DRL-BF-66	1078	1401
72	x 24	DRL-BF-72	1148	1488
42	x 24	DRR-BF-42	918	1192
48	x 24	DRR-BF-48	918	1192
60	x 24	DRR-BF-60	973	1238
66	x 24	DRR-BF-66	1078	1401
72	x 24	DRR-BF-72	1148	1488

How to Order:

- 1) Select Model Number:
RD-BBF-FF-7236
- 2) Specify Laminate Type (LP/HP):
RD-BBF-FF-7236-LP
- 3) Add Laminate/Edge Color: (See page 66)
RD-BBF-FF-7236-LP-WF236-Shadow Oak

Note: Additional upcharge will be applied for Premium and HD Premium colors. Please contact Customer Service for pricing and availability.

Prices shown are for standard stock laminate. Refer to page 66 for standard laminate colors. Refer to page 65 for edge profiles and page 67 for standard edgeband colors.

Grommets: \$26 List Scallop: \$40 List
Refer to page 11 for grommet and scallop cutout detail.

Reception Options

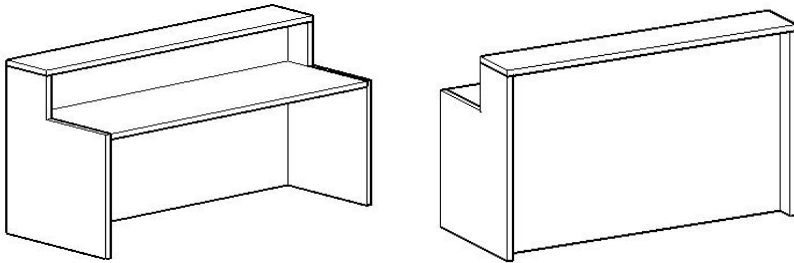

Desk Shell w/Transaction Top

W	D	H	Model No.	LP	HP
48	x 30	x 42	RD-S-4830-RF	1699	2425
60	x 30	x 42	RD-S-6030-RF	1804	2575
66	x 30	x 42	RD-S-6630-RF	1856	2650
72	x 30	x 42	RD-S-7230-RF	1906	2722
60	x 36	x 42	RD-S-6036-RF	1896	2706
72	x 36	x 42	RD-S-7236-RF	2008	2867

Panel Front

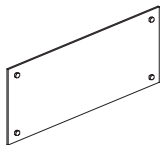

W	D	H	Model No.	LP	HP
54-1/2	x 1/2	x 25-1/4	PF	755	1078

Metal/Acrylic laminate options available. Please contact customer service for pricing and availability.

Clear Glass Top

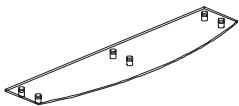

W	D	H	Model No.	List
72	x 18	x 1/2	CGT	1808

Includes polished chrome standoff. \$165 net crating charge will be applied.

Frosted Glass Top

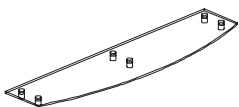

W	D	H	Model No.	List
72	x 18	x 1/2	FGT	2042

Includes polished chrome standoff. \$165 net crating charge will be applied.

Specifications:

- LP (Thermal Fused Laminate) - 1-1/8" thick
- HP (High Pressure Laminate) - 1-1/4" thick
- All Custom Crafters furniture is shipped fully assembled, unless otherwise noted.
- Custom Crafters is manufactured using scratch, spill and stain resistant high pressure laminate (HP) or Thermal Fused Laminate (LP). See page 66 for a listing of our standard laminate colors.
- Custom Crafters uses M-3 CARB2 compliant industrial grade particleboard for all furniture with moisture resistant PolyBak on the underside.
- Edge is 2mm PVC. See page 67 for colors.
- Glass Top and Panel Front includes standoffs.
- Other custom reception options available. Please contact customer service for other options and pricing.

How to Order:

- 1) Select Model Number:
LF4
- 2) Specify Laminate Type (LP/HP):
LF4-LP
- 3) Add Laminate Color: (See page 66)
LF4-LP-WF270

Note: Additional upcharge will be applied for Premium and HD Premium colors. Please contact Customer Service for pricing and availability.

Prices shown are for standard stock laminate. Refer to page 66 for standard laminate colors. Refer to page 65 for edge profiles and page 67 for standard edgeband colors.
Grommets: \$26 List Scallops: \$40 List
Refer to page 11 for grommet and scallop cutout detail.

Peninsula Desk

Square Top Peninsula Desk

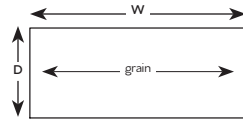
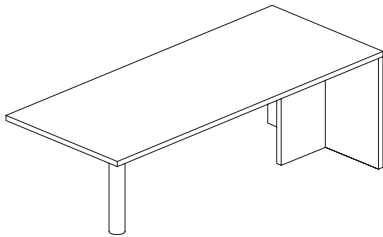

W	D	Model No.	LP	HP
60	X 30	STK-6030	695	990
60	X 36	STK-6036	767	1095
66	X 30	STK-6630	753	1045
66	X 36	STK-6636	821	1271
72	X 30	STK-7230	692	1069
72	X 36	STK-7236	750	1184

D-Top Peninsula Desk

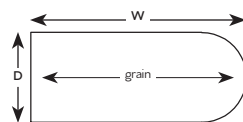
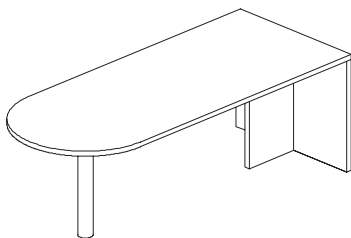

W	D	Model No.	LP	HP
60	X 30	DTK-6030	762	1087
60	X 36	DTK-6036	843	1203
66	X 30	DTK-6630	811	1159
66	X 36	DTK-6636	902	1287
72	X 30	DTK-7230	822	1174
72	X 36	DTK-7236	911	1300

Arc Top Peninsula Desk

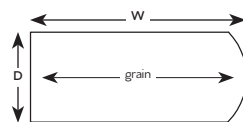
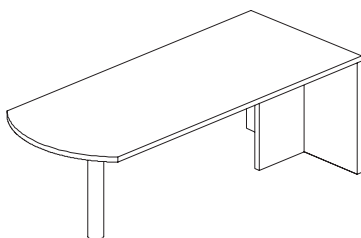

W	D	Model No.	LP	HP
60	X 30	ATK-6030	762	1087
60	X 36	ATK-6036	843	1203
66	X 30	ATK-6630	811	1159
66	X 36	ATK-6636	902	1288
72	X 30	ATK-7230	822	1174
72	X 36	ATK-7236	911	1300

Specifications:

- All Custom Crafters furniture is shipped unassembled.
- Custom Crafters is manufactured using scratch, spill and stain resistant high pressure laminate (HP) or Thermal Fused Laminate (LP). See page 66 for a listing of our standard laminate colors.
- Custom Crafters uses M-3 CARB2 compliant industrial grade particleboard for all furniture with moisture resistant PolyBak on the underside.
- Peninsula desks include a 3" diameter black metal powdercoat column leg and a T-Support.
- Edge is 2mm PVC. See page 67 for colors.
- Not to be used freestanding.
- LP (Thermal Fused Laminate) - 1-1/8" thick
- HP (High Pressure Laminate) - 1-1/4" thick

Peninsula Desk

Corner D-Top Peninsula Desk

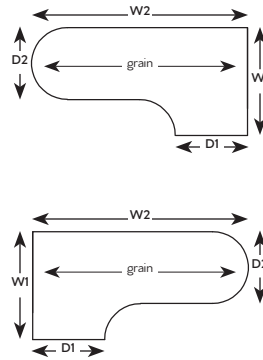
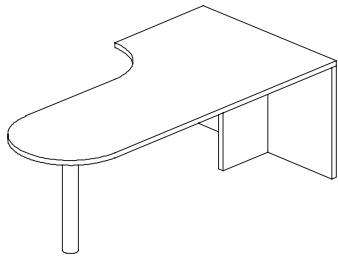

D1	D2	W1		Model No.	LP	HP
24	24	36	66	CDKL-24243666	1004	1430
24	24	36	72	CDKL-24243672	1010	1444
30	36	48	66	CDKL-30364866	1081	1544
30	36	48	72	CDKL-30364872	1089	1557
24	24	36	66	CDKR-24243666	1004	1430
24	24	36	72	CDKR-24243672	1010	1444
30	36	48	66	CDKR-30364866	1081	1544
30	36	48	72	CDKR-30364872	1089	1557

Corner P-Top Peninsula Desk

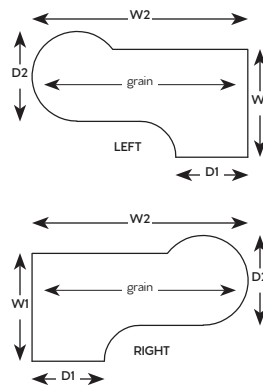
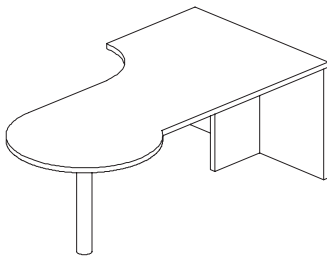

D1	D2	W1		Model No.	LP	HP
24	32	36	66	CPKL-24323666	1102	1575
24	32	36	72	CPKL-24323672	1113	1588
30	44	48	66	CPKL-30444866	1182	1687
30	44	48	72	CPKL-30444872	1190	1701
24	32	36	66	CPKR-24323666	1102	1575
24	32	36	72	CPKR-24323672	1113	1588
30	44	48	66	CPKR-30444866	1182	1687
30	44	48	72	CPKR-30444872	1190	1701

Specifications:

- All Custom Crafters furniture is shipped unassembled.
- Custom Crafters is manufactured using scratch, spill and stain resistant high pressure laminate (HP) or Thermal Fused Laminate (LP). See page 66 for a listing of our standard laminate colors.
- Custom Crafters uses M-3 CARB2 compliant industrial grade particleboard for all furniture with moisture resistant PolyBak on the underside.
- Peninsula desks include a 3" diameter black metal powdercoat column leg and a T-Support.
- Edge is 2mm PVC. See page 67 for colors.
- Not to be used freestanding.
- LP (Thermal Fused Laminate) - 1-1/8" thick
- HP (High Pressure Laminate) - 1-1/4" thick

Prices shown are for standard stock laminate. Refer to page 66 for standard laminate colors. Refer to page 65 for edge profiles and page 67 for standard edgeband colors.
 Grommets: \$26 List Scallops: \$40 List
 Refer to page 11 for grommet and scallop cutout detail.

Credenza

Shell Only

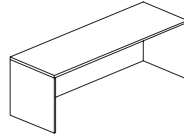

W	D	Model No.	LP	HP	DWG
42	x 24	CDZ-S-4224	615	878	40.0
48	x 24	CDZ-S-4824	646	922	41.0
60	x 24	CDZ-S-6024	741	1058	42.0
66	x 24	CDZ-S-6624	788	1126	43.0
72	x 24	CDZ-S-7224	835	1194	44.0

With Double Full Pedestals and Storage Cabinet with Doors: FF & FF

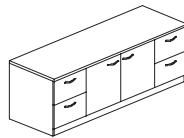

W	D	Model No.	LP	HP	DWG
60	x 24	CDZ-FF-HD-FF-60	2202	3145	45.0
66	x 24	CDZ-FF-HD-FF-66	2249	3214	46.0
72	x 24	CDZ-FF-HD-FF-72	2298	3283	47.0

Specifications:

- LP (Thermal Fused Laminate) - 1-1/8" thick
- HP (High Pressure Laminate) - 1-1/4" thick
- All Custom Crafters furniture is shipped fully assembled, unless otherwise noted.
- Custom Crafters is manufactured using scratch, spill and stain resistant high pressure laminate (HP) or Thermal Fused Laminate (LP). See page 66 for a listing of our standard laminate colors.
- Custom Crafters uses M-3 CARB2 compliant industrial grade particleboard for all furniture with moisture resis-tant PolyBak on the underside.
- Credenza includes Full Modesty Panel.
- Pedestal drawers operate on precision full extension slides. Hang rails are provided in all file drawers for front-to-back letter filing.
- Edge is 2mm PVC. See page 67 for colors.
- Full pedestals are 16-1/4"Wx23"Lx27-5/8"H.
- 3/4 pedestals are 16-1/4"Wx23"Lx18-1/2"H.
- Lateral files are 36"Wx23"Lx27-5/8"H.
- Credenza does not include locks.
- Locks are \$80 list each.

With Double 3/4 Pedestals and Storage Cabinet with Doors: BF & BF

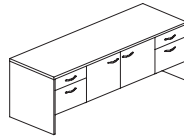

W	D	Model No.	LP	HP	DWG
60	x 24	CDZ-BF-HD-BF-60	1862	2659	48.0
66	x 24	CDZ-BF-HD-BF-66	1909	2726	49.0
72	x 24	CDZ-BF-HD-BF-72	1959	2796	50.0

With Double Full Pedestals : FF & FF

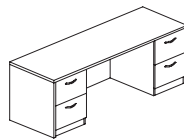

W	D	Model No.	LP	HP	DWG
60	x 24	CDZ-FF-FF-60	1730	2470	51.0
66	x 24	CDZ-FF-FF-66	1778	2538	52.0
72	x 24	CDZ-FF-FF-72	1826	2606	53.0

With Double 3/4 Pedestals : BF & BF

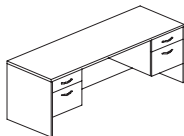

W	D	Model No.	LP	HP	DWG
60	x 24	CDZ-BF-BF-60	1496	2137	54.0
66	x 24	CDZ-BF-BF-66	1542	2204	55.0
72	x 24	CDZ-BF-BF-72	1590	2272	56.0

How to Order:

- 1) Select Model Number:
RD-BBF-FF-7236
- 2) Specify Laminate Type (LP/HP):
RD-BBF-FF-7236-LP
- 3) Add Laminate/Edge Color: (See page 66)
RD-BBF-FF-7236-LP-WF236-Shadow Oak

Note: Additional upcharge will be applied for Premium and HD Premium colors. Please contact Customer Service for pricing and availability.

With Single Lateral File

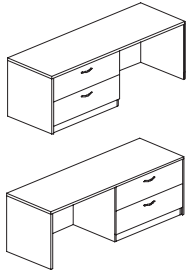

W	D	Model No.	LP	HP	DWG
60	x 24	CDZL-LF-60	1490	1910	57.0
66	x 24	CDZL-LF-66	1538	2195	58.0
72	x 24	CDZL-LF-72	1587	2265	59.0
60	x 24	CDZR-LF-60	1490	1910	60.0
66	x 24	CDZR-LF-66	1538	2195	61.0
72	x 24	CDZR-LF-72	1587	2265	62.0

With Double Lateral Files

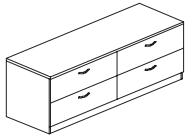

W	D	Model No.	LP	HP	DWG
66	x 24	CDZ-LF-LF-66	2286	3266	63.0
72	x 24	CDZ-LF-LF-72	2336	3337	64.0

With Lateral File and Storage Cabinet

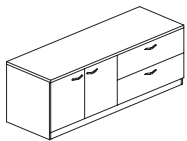

W	D	Model No.	LP	HP	DWG
66	x 24	CDZ-HD-LF-66	2009	2816	65.0
72	x 24	CDZ-HD-LF-72	2021	2940	66.0
66	x 24	CDZ-LF-HD-66	2009	2816	67.0
72	x 24	CDZ-LF-HD-72	2021	2940	68.0

With Two Storage Cabinets

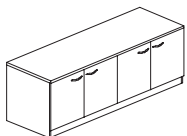

W	D	Model No.	LP	HP	DWG
60	x 24	CDZ-HD-HD-60	1683	2406	69.0
66	x 24	CDZ-HD-HD-66	1731	2501	70.0
72	x 24	CDZ-HD-HD-72	1780	2597	71.0

Buffet Credenza 36"H

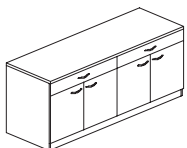

W	D	Model No.	LP	HP	DWG
60	x 24	CDZ-BUF-60	2115	3020	72.0
66	x 24	CDZ-BUF-66	2175	3107	73.0
72	x 24	CDZ-BUF-72	2226	3179	74.0
84	x 24	CDZ-BUF-84	2275	3249	75.0

Specifications:

- LP (Thermal Fused Laminate) - 1-1/8" thick
- HP (High Pressure Laminate) - 1-1/4" thick
- All Custom Crafters furniture is shipped fully assembled, unless otherwise noted.
- Custom Crafters is manufactured using scratch, spill and stain resistant high pressure laminate (HP) or Thermal Fused Laminate (LP). See page 66 for a listing of our standard laminate colors.
- Custom Crafters uses M-3 CARB2 compliant industrial grade particleboard for all furniture with moisture resistant PolyBak on the underside.
- Credenza includes Full Modesty Panel.
- Pedestal drawers operate on precision full extension slides. Hang rails are provided in all file drawers for front-to-back letter filing.
- Edge is 2mm PVC. See page 67 for colors.
- Full pedestals are 16-1/4"Wx23"Lx27-5/8"H.
- 3/4 pedestals are 16-1/4"Wx23"Lx18-1/2"H.
- Lateral files are 36"Wx23"Lx27-5/8"H.
- Credenza does not include locks.
- Locks are \$80 list each.

How to Order:

- 1) Select Model Number:
RD-BBF-FF-7236
- 2) Specify Laminate Type (LP/HP):
RD-BBF-FF-7236-LP
- 3) Add Laminate/Edge Color: (See page 66)
RD-BBF-FF-7236-LP-WF236-Shadow Oak

Note: Additional upcharge will be applied for Premium and HD Premium colors. Please contact Customer Service for pricing and availability.

Prices shown are for standard stock laminate. Refer to page 66 for standard laminate colors. Refer to page 65 for edge profiles and page 67 for standard edgeband colors.
Grommets: \$26 List Scallops: \$40 List
Refer to page 11 for grommet and scallop cutout detail.

Hutch and Wall Mounted Storage

Wall Mounted Storage Cabinets

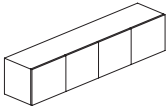

W	D	H	Model No.	LP	HP	DWG
30	x 15	x 18	WM-30	655	935	29.0
36	x 15	x 18	WM-36	726	1039	30.0
42	x 15	x 18	WM-42	803	1148	31.0
48	x 15	x 18	WM-48	882	1258	32.0

Hutch

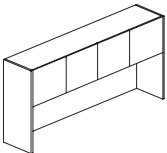

W	D	H	Model No.	LP	HP	DWG
36	x 15	x 41-1/4	H-36	902	1290	33.0
42	x 15	x 41-1/4	H-42	1004	1402	34.0
48	x 15	x 41-1/4	H-48	1090	1554	35.0
60	x 15	x 41-1/4	H-60	1262	1803	36.0
66	x 15	x 41-1/4	H-66	1353	1930	37.0
72	x 15	x 41-1/4	H-72	1438	2054	38.0
78	x 15	x 41-1/4	H-78	1539	2199	39.0

Lateral Files

Undersurface Lateral Files without Finish Top

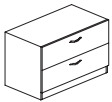

W	D	H	Model No.	LP	HP	DWG
36	x 23	x 27-5/8	LF	957	1369	26.0

Freestanding Lateral Files with Two Drawers

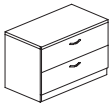

W	D	H	Model No.	LP	HP	DWG
36	x 23	x 29-1/2	LFT2	1079	1540	27.0

Includes anti-tip mechanism.

Lateral Files with Four Drawers



W	D	H	Model No.	LP	HP	DWG
36	x 23	x 55-1/4	LFT4	2276	3011	28.0

Specifications:

- LP (Thermal Fused Laminate) - 1-1/8" thick
- HP (High Pressure Laminate) - 1-1/4" thick
- All Custom Crafters furniture is shipped fully assembled, unless otherwise noted.
- Custom Crafters is manufactured using scratch, spill and stain resistant high pressure laminate (HP) or Thermal Fused Laminate (LP). See page 66 for a listing of our standard laminate colors.
- Custom Crafters uses M-3 CARB2 compliant industrial grade particleboard for all furniture with moisture resistant PolyBak on the underside.
- Pedestal drawers operate on precision full extension slides. Hang rails are provided in all file drawers for front-to-back letter filing.
- Edge is 2mm PVC. See page 67 for colors.
- All Hutch unit is equipped with self-closing, adjustable hinged doors and valance to hide the task light
- Hutch unit features two grommets at the bottom for electrical cords.
- Storage unit, Lateral and Pedestal Files does not include locks.
- Locks are \$80 list each.

Prices shown are for standard stock laminate. Refer to page 66 for standard laminate colors. Refer to page 65 for edge profiles and page 67 for standard edgeband colors.
 Grommets: \$26 List Scallop: \$40 List
 Refer to page 11 for grommet and scallop cutout detail.

Pedestal without Top : Box/Box/File



W	D	H	Model No.	LP	HP	DWG
17	x 23	x 27-5/8	BBF	677	967	1.0

Pedestal Files

Pedestal without Top : File/File



W	D	H	Model No.	LP	HP	DWG
17	x 23	x 27-5/8	FF	677	967	2.0

Pedestal with Finish Top : Box/Box/File



W	D	H	Model No.	LP	HP	DWG
17	x 23	x 27-5/8	BBFT	762	1087	3.0

Casters may be added to pedestal to be converted to a mobile pedestal at an additional upcharge of \$90 List.

Pedestal with Finish Top : File/File



W	D	H	Model No.	LP	HP	DWG
17	x 23	x 27-5/8	FFT	762	1087	4.0

Casters may be added to pedestal to be converted to a mobile pedestal at an additional upcharge of \$90 List.

Mobile Pedestal with Cushion Top : Box/File



W	D	H	Model No.	LP	HP	DWG
17	x 23	x 20	BFM	1001	1424	5.0

Mobile pedestal includes cushion top. Jet Black fabric or COM only. COM fabric is 3/4 yard minimum per mobile pedestal.

Specifications:

- LP (Thermal Fused Laminate) - 1-1/8" thick
- HP (High Pressure Laminate) - 1-1/4" thick
- All Custom Crafters furniture is shipped fully assembled, unless otherwise noted.
- Custom Crafters is manufactured using scratch, spill and stain resistant high pressure laminate (HP) or Thermal Fused Laminate (LP). See page 66 for a listing of our standard laminate colors.
- Custom Crafters uses M-3 CARB2 compliant industrial grade particleboard for all furniture with moisture resistant PolyBak on the underside.
- Pedestal drawers operate on precision full extension slides. Hang rails are provided in all file drawers for front-to-back letter filing.
- Edge is 2mm PVC. See page 67 for colors.
- Storage cabinets include one adjustable shelf and non-locking doors.
- Storage unit, Lateral and Pedestal Files does not include locks.
- Locks are \$80 list each.

Storage Cabinet Without Finish Top

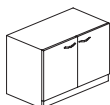

W	D	H	Model No.	LP	HP	DWG
36	x 20	x 27-5/8	HD	762	1087	6.0

Storage

Storage Cabinet With Finish Top

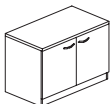

W	D	H	Model No.	LP	HP	DWG
36	x 20	x 29-1/2	HDT	859	1223	7.0

How to Order:

- 1) Select Model Number:
LF4
- 2) Specify Laminate Type (LP/HP):
LF4-LP
- 3) Add Laminate Color: (See page 66)
LF4-LP-WF270

Note: Additional upcharge will be applied for Premium and HD Premium colors. Please contact Customer Service for pricing and availability.

Prices shown are for standard stock laminate. Refer to page 66 for standard laminate colors. Refer to page 65 for edge profiles and page 67 for standard edgeband colors.
Grommets: \$26 List Scallop: \$40 List
Refer to page 11 for grommet and scallop cutout detail.

Storage

Low Storage Unit

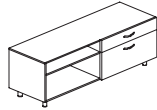
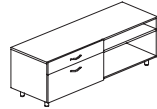

W	D	H	Model No.	LP	HP	DWG
60	x 20	x 24	LOSL-60	1271	1650	8.0
66	x 20	x 24	LOSL-66	1471	1909	9.0
72	x 20	x 24	LOSL-72	1577	2049	10.0
60	x 20	x 24	LOSR-60	1271	1650	8.0
66	x 20	x 24	LOSR-66	1471	1909	9.0
72	x 20	x 24	LOSR-72	1577	2049	10.0

Cushion top

30x20 = \$369 List

36x20 = \$385 List

Bookcases

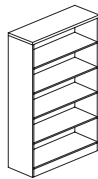

Without Doors

2 Shelf	36	x 13	x 28	BK2	487	697	11.0
3 Shelf	36	x 13	x 41	BK3	631	900	12.0
4 Shelf	36	x 13	x 54	BK4	748	1065	13.0
5 Shelf	36	x 13	x 67-1/2	BK5	864	1235	14.0

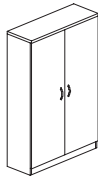

With Doors

2 Shelf	36	x 13	x 28	BKD2	972	1390	15.0
3 Shelf	36	x 13	x 41	BKD3	1261	1801	16.0
4 Shelf	36	x 13	x 54	BKD4	1493	2132	17.0
5 Shelf	36	x 13	x 67-1/2	BKD5	1729	2468	18.0

Specifications:

- LP (Thermal Fused Laminate) - 1-1/8" thick
- HP (High Pressure Laminate) - 1-1/4" thick
- All Custom Crafters furniture is shipped fully assembled, unless otherwise noted.
- Custom Crafters is manufactured using scratch, spill and stain resistant high pressure laminate (HP) or Thermal Fused Laminate (LP). See page 66 for a listing of our standard laminate colors.
- Custom Crafters uses M-3 CARB2 compliant industrial grade particleboard for all furniture with moisture resistant PolyBak on the underside.
- Pedestal drawers operate on precision full extension slides. Hang rails are provided in all file drawers for front-to-back letter filing.
- Edge is 2mm PVC. See page 67 for colors.

How to Order:

- 1) Select Model Number:
LF4
- 2) Specify Laminate Type (LP/HP):
LF4-LP
- 3) Add Laminate Color: (See page 66)
LF4-LP-WF270

Note: Additional upcharge will be applied for Premium and HD Premium colors. Please contact Customer Service for pricing and availability.

Locker Unit

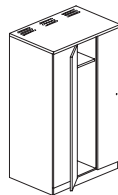
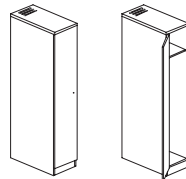

W	D	H	Model No.	LP	HP	DWG
Single Locker						
12	x 18	x 72	LK1	1259	1799	19.0

Three Pack Locker						
12	x 18	x 72	LK3	3220	4601	20.0

Includes top shelf, coat rod, and standard cam locks. Optional programmable combination locks with code-finder may be added for an additional upcharge of \$205 List.

Storage Cabinet

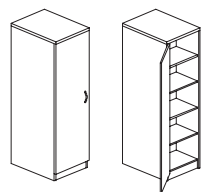

W	D	H	Model No.	LP	HP	DWG
18	x 24	x 72	SCB	1697	2425	21.0

Wardrobe Storage Cabinet

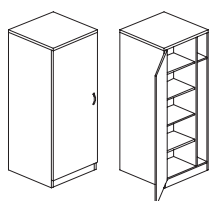

W	D	H	Model No.	LP	HP	DWG
24	x 24	x 72	WD	1726	2467	22.0

6" Wardrobe section includes top shelf and coat rod.

Storage Cabinet Combo 1

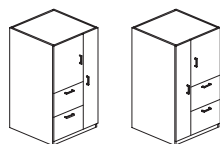

W	D	H	Model No.	LP	HP	DWG
24	x 24	x 50	SCC-1	1604	2286	23.0

Includes wardrobe, lateral file and storage cabinet.
8" wardrobe section includes top shelf and coat rod.

Storage Cabinet Combo 2

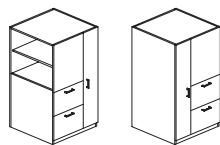

W	D	H	Model No.	LP	HP	DWG
24	x 24	x 50	SCC-2	1604	2286	24.0

Includes wardrobe, lateral file and bookcase. 8" wardrobe section includes top shelf and coat rod.

Storage Cabinet With Lateral File

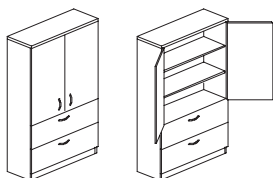

W	D	H	Model No.	LP	HP	DWG
36	x 24	x 72	SLF	2529	3615	25.0

Specifications:

- LP (Thermal Fused Laminate) - 1-1/8" thick
- HP (High Pressure Laminate) - 1-1/4" thick
- All Custom Crafters furniture is shipped fully assembled, unless otherwise noted.
- Custom Crafters is manufactured using scratch, spill and stain resistant high pressure laminate (HP) or Thermal Fused Laminate (LP). See page 66 for a listing of our standard laminate colors.
- Custom Crafters uses M-3 CARB2 compliant industrial grade particleboard for all furniture with moisture resistant PolyBak on the underside.
- Pedestal drawers operate on precision full extension slides. Hang rails are provided in all file drawers for front-to-back letter filing.
- Edge is 2mm PVC. See page 67 for colors.
- Storage cabinets include adjustable shelves and non-locking doors.

How to Order:

- 1) Select Model Number:
LF4
- 2) Specify Laminate Type (LP/HP):
LF4-LP
- 3) Add Laminate Color: (See page 66)
LF4-LP-WF270

Note: Additional upcharge will be applied for Premium and HD Premium colors. Please contact Customer Service for pricing and availability.

Prices shown are for standard stock laminate. Refer to page 66 for standard laminate colors. Refer to page 65 for edge profiles and page 67 for standard edgeband colors.
Grommets: \$26 List Scallops: \$40 List
Refer to page 11 for grommet and scallop cutout detail.

Rotating Power Unit



Conference Table Power Unit



W	D	H	Model No.	List
15-7/16	x 4-3/4	x 4-3/8	CPU	1353

The full-size design offers one VGA connection, three data ports and three power outlets for multiple users in conference room settings.



Specifications:

- Finish comes in Satin Aluminum.
- Standard electric cord available in 9 foot length.
- Chicago code option available.
- Safety Photo Electric Eye prevents rotation when obstructed.
- UL CUL SE Approved
- Spill Test Approved
- Quality Inspected
- 2-year Warranty

Rotating Power Unit

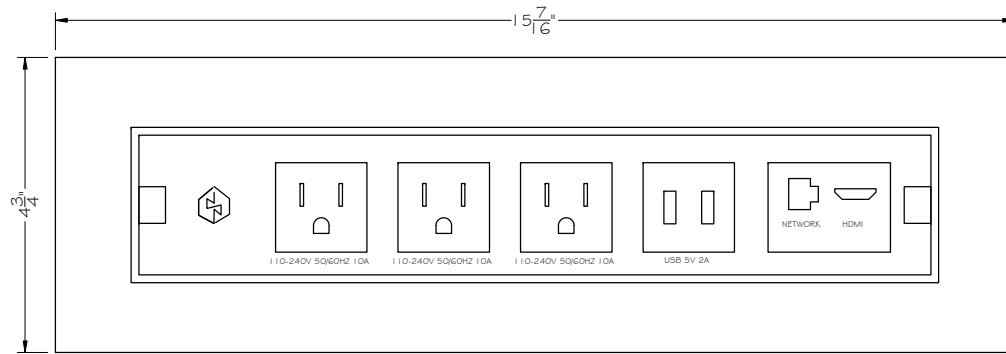

Ports

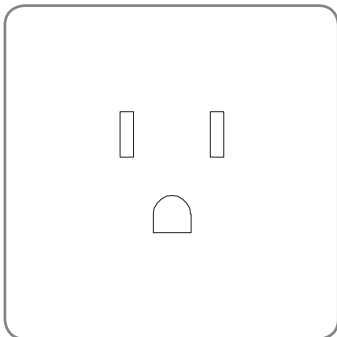

North American 110Volt
Power Outlet

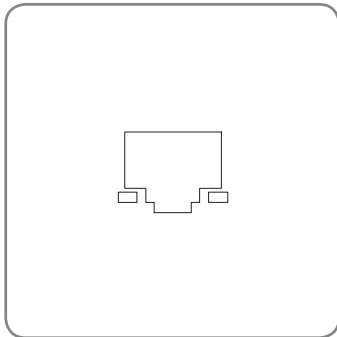

RJ-45 Category 5e/6 Data
Port

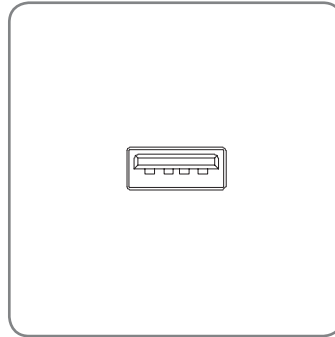

USB Pass-Through Data
Port / USB 5 Volt Power
Outlet

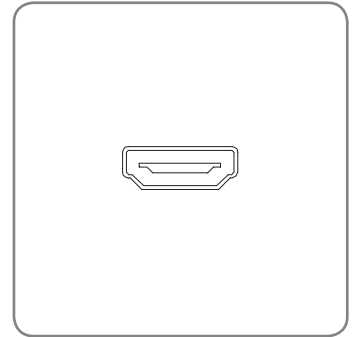

HDMI Video Connector

Please Note:

- AVAILABLE IN PLUG-IN AND HARDWIRE OPTIONS

Tackboard

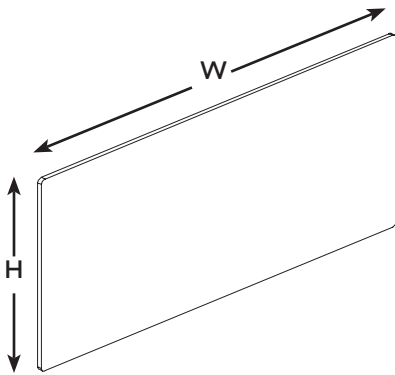

H	W	Model No.	List	
12	x	24	TB24	311
12	x	36	TB36	382
12	x	48	TB48	474
12	x	60	TB60	612
12	x	72	TB72	704
12	x	84	TB84	770
16	x	24	TB24	400
16	x	36	TB36	516
16	x	48	TB48	602
16	x	60	TB60	833
16	x	72	TB72	964
16	x	84	TB84	1037
24	x	24	TB24	380
24	x	36	TB36	525
24	x	48	TB48	649
24	x	60	TB60	863
24	x	72	TB72	985
24	x	84	TB84	1063

Laminate Whiteboard

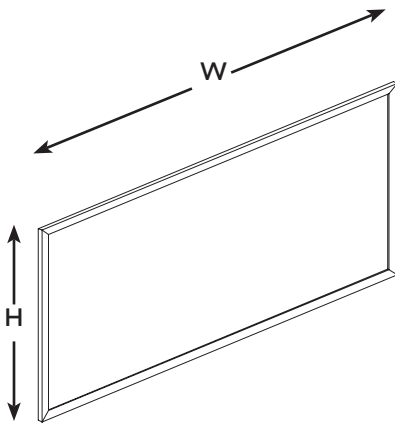

T-Mold

H	W	Model No.	List	
24	x	36	TML2436	604
24	x	48	TML2448	712
36	x	36	TML3636	776
48	x	48	TML4848	1250
48	x	60	TML4860	1427
48	x	72	TML4872	1529
48	x	84	TML4884	1727
48	x	96	TML4896	1923

Maple Frame

H	W	Model No.	List	
24	x	36	MFL2436	1154
24	x	48	MFL2448	1331
36	x	36	MFL3636	1390
48	x	48	MFL4848	1939
48	x	60	MFL4860	2297
48	x	72	MFL4872	2500
48	x	84	MFL4884	2787
48	x	96	MFL4896	3074

Specifications:

Laminate whiteboard include universal bracket for Mounting. Please contact customer service for custom sizes and pricing.

Standard Glass Whiteboard

H		W	Model No.	List
36	x	48	GWB01-3648	Check Pricing
42	x	60	GWB01-4260	Check Pricing
42	x	72	GWB01-4272	Check Pricing

The glass whiteboard gives a vibrant backdrop to media presentations. This artistic dry-erase board writes smoothly on optically clear glass that will not leave "ghost" marks over time. The glass whiteboard is easily distinguished from the traditional whiteboard.

Starphire® Glass Whiteboard

H		W	Model No.	List
36	x	48	GWB02-3648	Check Pricing
42	x	60	GWB02-4260	Check Pricing
42	x	72	GWB02-4272	Check Pricing

Take the glass whiteboard to the next level of clarity and quality with the ultimate in brilliant transparency. Starphire glass whiteboard is lead-free and low iron, lending an ultra-clear, pure white color to the board, vividly displaying presentations and dry-erase markers. It is sure to give a cutting-edge touch to your office space you have been looking for.

Glass Whiteboard

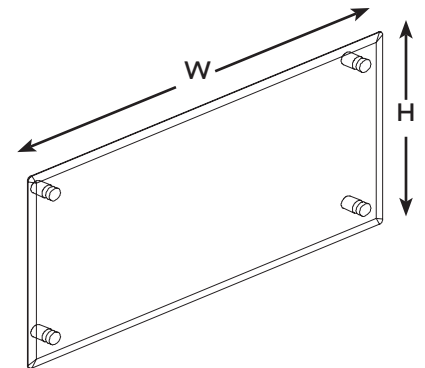

Projections

Glass whiteboards are the perfect medium for projections. The smooth white surface conveys true colors in full light atmospheres.

Marker Board

The glass whiteboard also doubles as a dry erase marker board, writing smoothly and erasing cleanly, never leaving "ghost" marks.

The Look

Polished edges and stainless steel standoffs complete the upgraded look.

Safety

Every glass whiteboard is heat-tempered much like a car windshield, making the glass whiteboard four times stonger than regular glass. The boards also include an adhered safety backing that prevents the glass from dislodging, should it endure damage.

Glass whiteboards are the epitome of versatility. Conduct meetings, display projections, outline ideas and brainstorm all with one product.

Shipping

\$327 net crating charge will be applied.

Aluminium Tray

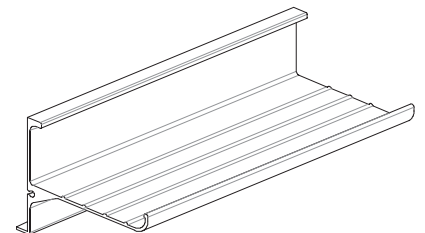

Specifications:

- A set of dry-erase markers, one eraser and a 24" extruded aluminium tray is included with every glass white board.
- Aluminium tray is attached via double-sided tape.

Hardwares

Grommet Cover

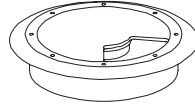

D	H	Model No.	List
3	x 3/4	GROMMET	15.42

Black Standard. Other colors available upon request. Please contact customer service for availability and pricing.

Angle Mounting Bracket

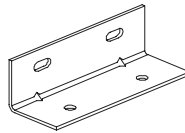

D	W	H	Model No.	List
1-1/16	x 3	x 1-1/16	AMB	4.10

Includes four screws.

Leveler

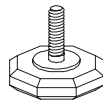

D	H	Model No.	List
1-1/2	x 1-5/8	LVR1	1.50

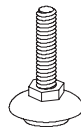

1-3/16	2-1/2	LVR2	3.15
--------	-------	------	------

Threaded Insert



D	H	Model No.	List
9/16	x 15/16	TIN	1.50

Aluminium Rectangular Leg

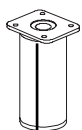

D	W	H	Model No.	List
1-1/2	x 1-1/2	x 4	J11806	5.71

Mending Plates

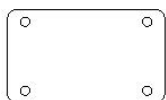

D	W	H	Model No.	List
1	x 4	x 1/8	MP1	3.50

Includes screws.

Tight Joint Fastner



	D	W	H	Model No.	List
Bolt Size		1/4	x 3-1/2	76-03-020	3.55
Bolt Plate Size	7/16	x 1	x 3/16		

Hex head. Used for joining countertops and panels. Zinc Finish.

Standard Pulls

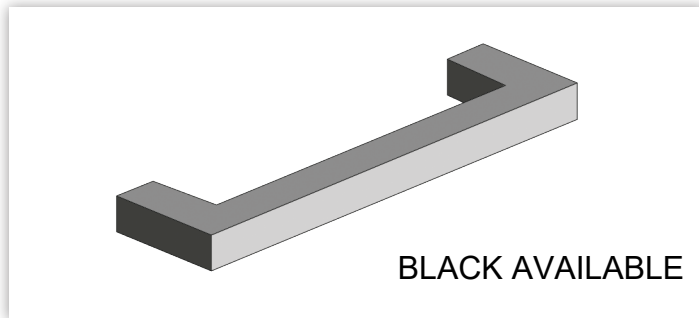

(P1) Aluminium Brushing

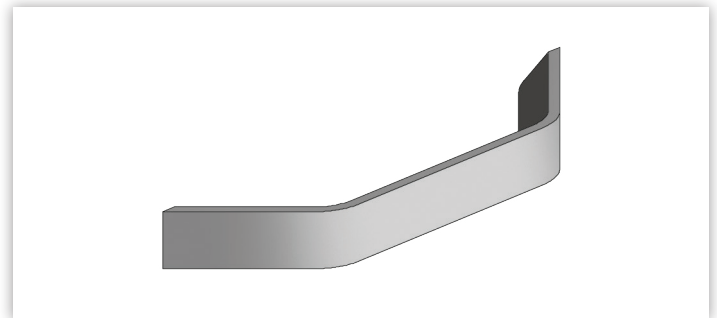

(P2) Matte Aluminium

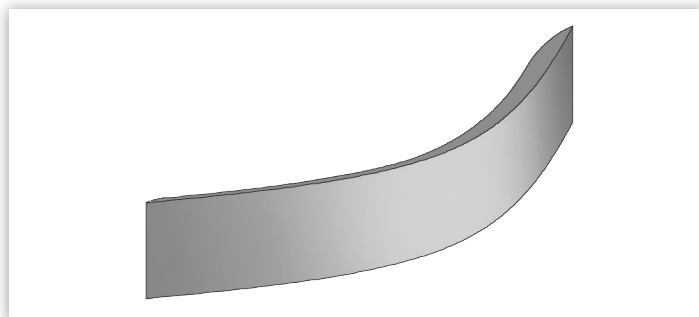

(P3) Matte Aluminium

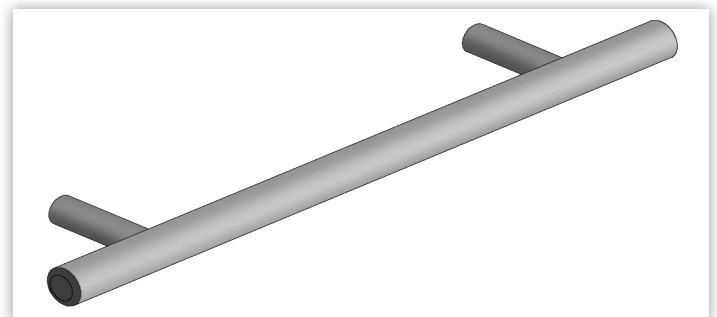

(P4) Stainless Steel Brushing

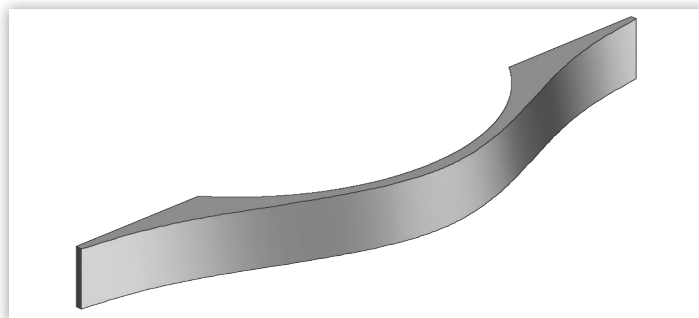

(P5) Aluminium Brushing

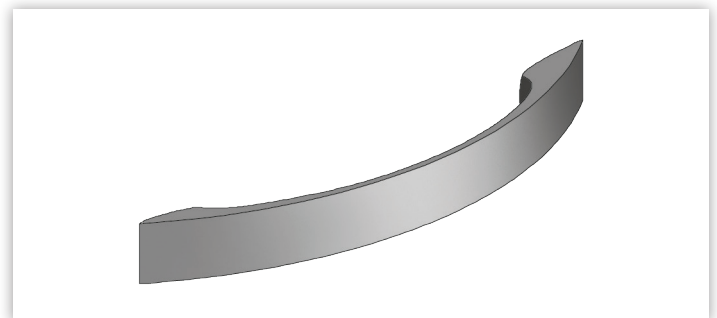

(P6) Aluminium Brushing

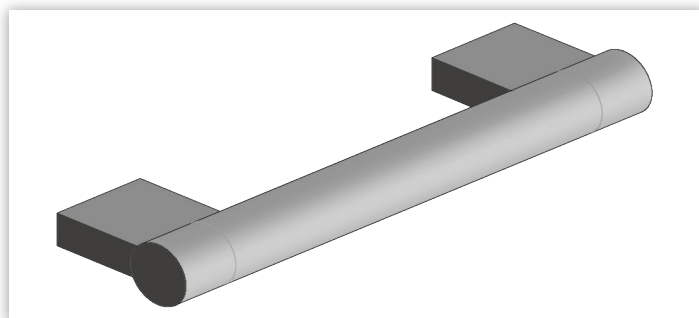

(P7) Matte Aluminium

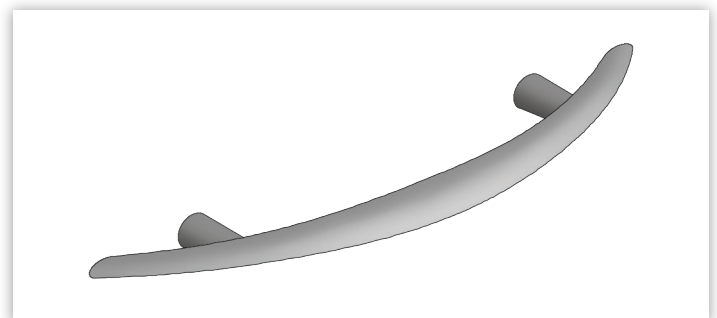

(P8) Aluminium Brushing

Edge Profile

Model No.	Thickness	Material	Description
-----------	-----------	----------	-------------

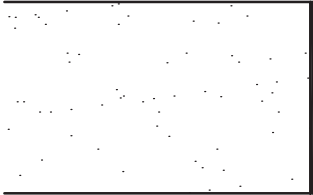

S1 0.030" HP Self edge

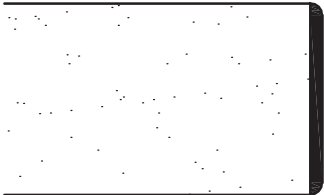

S2 0.078" (2mm) PVC With 2mm eased edge

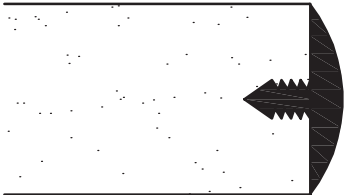

TM 0.212" T-Mold Crescent edge.

Please Note:
 Additional edge profile options are available. Please contact customer service for availability and pricing.

Thermally Fused Laminate Colors (LP)/ Value Series



White (W100)

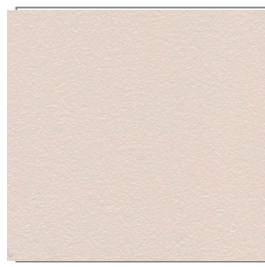

Willow (SF255)



Desert Glow (WF100)

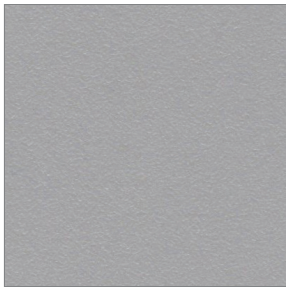

Fog Grey (SF213)

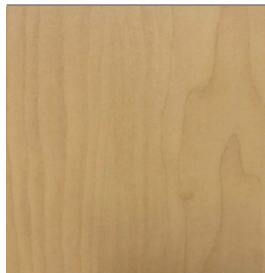

Cabinet Maple (WF270)

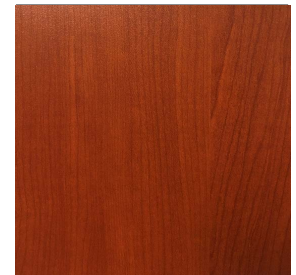

Autumn Glow (WF101)

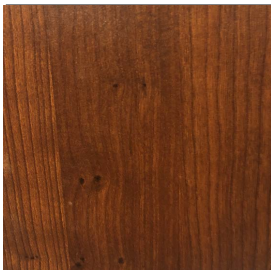

Ankara Cherry (WF236)

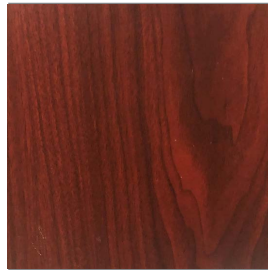

Brazilian Walnut (WF220)



Sable Glow (WF228)

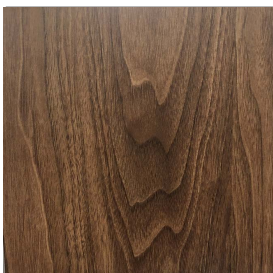

Chique (WF442)

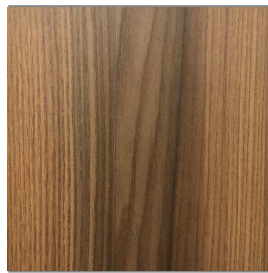

Karuna Ash (WF452)



Pewter Pine (WF377)

Please note:

· Please refer to the Wilsonart Contract Standard for Standard High Pressure Laminate (HP) Colors. Additional upcharge will be applied for Premium and HD Premium colors. Please contact Customer Service for pricing and availability.

· The color representations shown are subject to your printer and monitor resolution settings. Physical samples are recommended before finalizing any finish specifications.



customcrafters

7540 W Roosevelt Rd, Forest Park, IL 60130

www.customcrafterschicago.com

(708) 546-5841